

Analysis of taxonomic distinctness and priority conservation areas as a basis for heritage enhancement of floristic diversity: the case of the ‘hotspot’ of the islands of Numidia (North-Eastern Algeria)

Tarek Hamel¹, Noelia Hidalgo Triana², Amel Meddad-Hamza¹, Amir Boulemtafes¹, Nabila Souilah³, Gérard de Bélair⁴ & Ángel Enrique Salvo Tierra²

Received: 21 March 2022 / Accepted: 15 September 2022 / Published online: 14 November 2022

Abstract. The identification of priority conservation areas (PCA) plays an important role in biodiversity conservation, but uncertainties create challenges for conservation planning. The objective was to test a method based on ‘taxonomic distinctness’ (TD) and to identify PCA to quantify the heritage value of a territory and establish the most appropriate conservation measures. The researchers performed a systematic and phytogeographical analysis of ten islands in northeastern Algeria, a biological hotspot with heterogeneous ecosystem types and subject to socio-economic pressures. The biological diversity represented by 223 species in these environments reflects a high rate of endemism (13%). The floristic similarity between the islands is estimated at 89.9%. Additionally, four distinct plant groups have been identified by the canonical correspondence analysis (CCA). These groupings are linked to the edaphic characteristics and the degree of insularity.

Keywords: Conservation, endemic, floristic similarity, island flora, Numidia, taxonomic distinction.

How to cite: Hamel, T., Hidalgo Triana, N., Meddad-Hamza, A., Boulemtafes, A., Souilah, N., de Bélair, G. & Salvo Tierra, A.E. 2022. Analysis of taxonomic distinctness and priority conservation areas as a basis for heritage enhancement of floristic diversity: the case of the ‘hotspot’ of the islands of Numidia (North-Eastern Algeria). *Mediterr. Bot.* 44, e81225. <https://doi.org/10.5209/mbot.81225>.

Introduction

The UN’s Sustainable Development Goals (SDGs) aim to promote prosperity while protecting the planet. SDG 15 is dedicated to “preserving and restoring terrestrial ecosystems, ensuring that their biodiversity and the ecosystem services they provide are exploited in a sustainable manner” (<https://www.un.org/sustainabledevelopment/fr/biodiversity/>). According to the 2019 Global Biodiversity and Ecosystem Services Assessment Report, many species worldwide are already threatened with extinction, conservation is essential (Díaz *et al.*, 2019). There is a need for data (Chiarucci *et al.*, 2010), ideally from quantitative biogeography, a field that generates knowledge about the biodiversity of territories (Murguía & Rojas, 2010).

Island ecosystems typically host remarkable biological resources. Home to an array of endemic species (Médail & Myers, 2004) island ecosystems constitute veritable laboratories for studying living organisms (Whitehead & Jones, 1969; Höner & Greuter, 1988; Médail & Vidal, 1998). Such habitats often show

biocoenoses, both in terms of the floristic diversity and function (Passeti *et al.*, 2012). The main threats facing the flora of the Mediterranean islands are mainly due to pressures of anthropogenic origin: urbanization, tourism and recreation, fires, introduction of invasive alien species, not to mention the climate crisis which is causing an aggravation of these risks. Socio-economic pressures significantly threaten the flora of islands in the Mediterranean Sea; therefore, reliable data are necessary for conservation (Montmollin & de Strahm, 2010).

The Mediterranean Basin hosts numerous islands (Greuter 1995; Delanoë *et al.*, 1996), including North African waters, belonging to regional biodiversity hotspots such as the Betico-Rifain and Kabylia-Numidia-Kroumiria complexes (Médail & Quézel, 1997; Véla & Benhouhou, 2007). Their geographical position, often close to the presumed medium glacial refuges (Médail & Diadéma, 2009), probably supported them as refuges for biodiversity during the Ice Age, especially when their surface area increased considerably after declines in sea level. Today, they again appear to be sites

¹ Department of Biology, Faculty of Sciences, Badji Mokhtar University, Annaba 23000, Algeria. Email: tarek_hamel@yahoo.fr

² Department of Botany and Plant Physiology (Botany Area), University of Malaga, Blvr. Louis Pasteur, 31, 29010 Málaga, Spain.

³ Laboratory of Optimization of Agricultural Production in Sub-Humid Zones (LOPAZS), Faculty of Science, University of Skikda, Skikda 21000, Algeria

⁴ Badji Mokhtar University, Annaba 23000, Algeria.

conducive to micro-speciation and refuges for certain rare and / or vulnerable species (Greuter, 1995).

Most studies of that region conducted in Algeria have examined the impact of seabirds on plant communities (Benhamiche-Hanifi & Moulai, 2012; Bougaham & Moulai, 2013; Ghermaoui *et al.*, 2016; Bouyahmed & Moulai, 2018; Bahi *et al.*, 2019); only a few have examined the island flora and even then, only a handful of island in western Numidia, as well as central and western Algeria (Delauge & Véla, 2007; Véla, 2008, Véla & Pavon, 2012; Véla, 2017).

The identification of priority conservation areas (PCA) can preserve the floristic value of hotspots while promoting sustainable development and balancing the conservation and development of heritage sites (Wang *et al.*, 2022). This article aims to provide quantitative values for decision-making about land use and the conservation of ecosystems. Thus, the objective of our study was to test a method based on taxonomic distinctness (TD; Salvo Tierra *et al.*, 2021) in order to quantify the heritage value of a territory and establish the most appropriate measures for conserving it in accordance with SDG 15, as well as to identify PCA following the methodology implemented by Vane-Wright (1991). This method has been proposed by Salvo Tierra & García Verdugo (1988), Murguía & Rojas (2001) and Salvo Tierra *et al.* (2020), obtaining results with conservation applicability. The method required a systematic phytogeographic analysis of 10 islands in north-eastern Algeria, an island group in a hotspot with heterogeneous types of ecosystems and subject to socioeconomic pressures.

Material and methods

The island complex examined

The study area is part of the 11th regional biodiversity hotspot in the Mediterranean, called “Kabylias–Numidia–Kroumiria” (Véla & Benhouhou, 2007), and covers the Important Plant Area (IPA) called “El Kala 1 and Edough peninsula” (Yahi *et al.*, 2012; Benhouhou *et al.*, 2018).

The islands in this study are scattered along the coast of north-eastern Algeria, or “K3” according to the biogeographic subdivision proposed by Quézel & Santa (1962–1963) (Figure 1). They are located in the Tunisian border and to the west the wilaya of Skikda between the coordinates 36°55'16 "N; 8°32'53" E to the east of El Kala (ex. La Calle) and 37°4'49"N; 7°9'44" E west of the Edough peninsula. Rainfall is highly variable, ranging from 910 mm per year in El Kala, including the Island of France and the island of Callisar and Boutribicha, to 614 mm at Cape of Fer (including Toughnechet Island) (Seltzer, 1946). The region manifests geomorphological and pedological diversity, undifferentiated Quaternary Numidian sandstone and granite, which has nurtured a multiplicity of ecological niches for the flora (Marre, 1992). The study recorded also the physiographic variables of each island (Table 1).

Proposed methodology

Our method was based on the selection of operational geographic units (OGU), each defined by its geographic characteristics. Thus, on each of the 10 islands studied, the soil variables were considered: (1) electrical conductivity; (2) pH and nitrate level were examined following Mathieu and Pieltain’s method (2003); (3) organic matter following AFNOR’s method (Anon., 1999).

Floristic study

The islands studied were then subjected to phyto-ecological monitoring. The vegetation was exhaustively studied in the spring from 2015 to 2019, and the taxa inventoried were identified according to Quézel & Santa (1962–1963), Maire (1952–1987), Blanca *et al.* 2009, Dobignard & Chatelain (2010–2013), and APD (2022). The rarity of taxa was in reference to the flora of Quézel and Santa (1962–1963) and according to our observations in the field, namely the following statuses: rare (R) and very rare (RR) for non-endemic taxa. For endemic taxa, the classification was as follows: fairly common (FC), and fairly rare (FR).

The characterization of the threatened species presents on the islands studied was carried out on the basis of evaluation criteria established by the International Union for the Conservation of Nature in 2022 (IUCN, 2022) and according to the only list of non-cultivated plant species. protected in Algeria (JORA, 2012).

The biological types (Raunkiaer, 1934) of the different taxa have been assigned based on Pignatti (1982), Blanca *et al.* (2009), and Tison & de Foucault (2014). The chorological characterization was carried out based in the flora of Andalusia (Blanca *et al.*, 2009), whereas the eight endemic elements followed the flora of Italia (Pignatti, 1982) and the synonymic index of Dobignard and Chatelain (2010–2013).

Statistical analysis

The 10 islands (coded for “presence” or “absence”) were subjected to Canonical Correspondence Analysis (CCA), which allowed visualizing the explanatory percentage of one variable compared to the others (Ter Braak 1995). These analyses were performed using the R computer language (ade4 package, version 3.0.2) (R Development Core Team 2013). In turn, the basic data matrix (BDM) allowed a clustering analysis using the software PAST version 3.25 (Hammer, 2019) both in “q” mode to determine the similarity of the OGU groups biogeographic identity, (i.e., operational biogeographic units, OBU); and in “r” mode to determine groups of taxa with similar territorial distribution or similar corotypes. OBUs Bray & Curtis’s analysis (1957) was followed by an examination of taxonomic distance (in our case, biogeographic distance) in which the presence/absence of BDM was subjected to a double standardisation such that each taxon’s final values in each OGU reflected the degree of rarity within the territorial set. The distance half-matrix

was useful both for observing the degree of strength of the biological boundaries between OGUs, and for elaborating on the dendrogram as an instrument to determine OBUs, which were obtained by use of the most weighted pair group method with an averaging (WPGMA) algorithm recommended when extending assemblies. Corotypes were determined by means of k-means method (Likas *et al.*, 2003, Jain, 2009), as advised when the number of taxa

is high, to obtain robust values as the analysis is repeated at different levels of k. Coincidence in identical groups at different levels gave consistency to the corotypes formed. The obtained corotypes and the biogeographic boundaries identified (i.e. with little similarity between neighbouring pairs of OGUs) served to characterize the OBUs, which was very useful for the descriptions once the heritage values were determined.

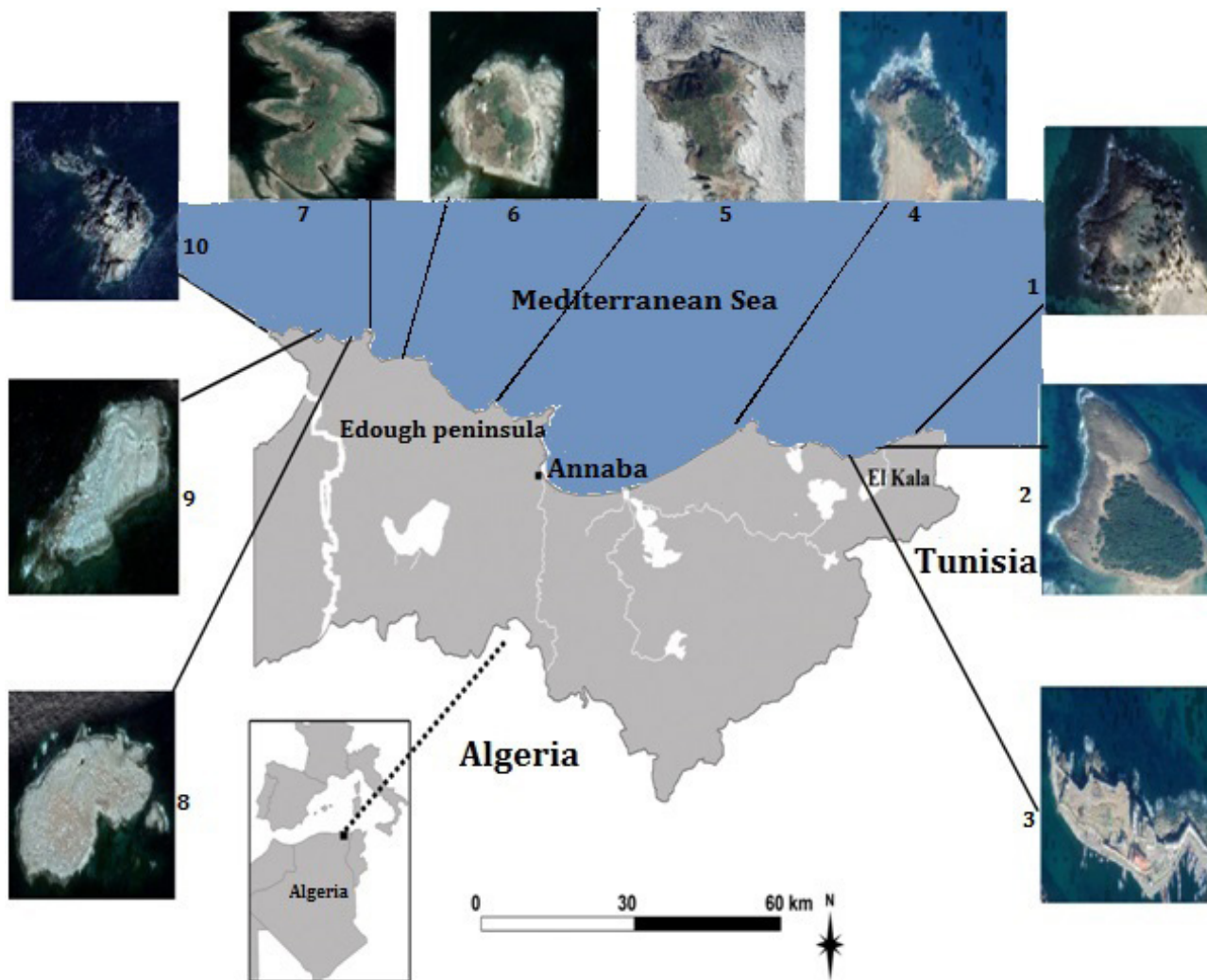

Figure 1. Location of studied islands

Table 1. Physio-geographic characteristics of the sampled islands.

Region (Important Plants Area, IPA)	Islands	Geographical coordinates (GPS)	Area (m ²)	Altitude (m)	Distance to continent (m)
El Kala 1	1. Boutribicha	36°55'16"N;8°32'53"E	14.840	7	6
	2. Callisar	36°54'21"N;8°29'34"E	17.288	4	4
	3. Island of France	36°53'56"N;8°26'33"E	27.942	7	5
	4. Hennaya	36°56'23"N;8°12'0.7"E	6.570	4	9
	5. Pain Sucre	36°58'36"N;7°39'28"E	33.751	32	3
Edough peninsula	6. Roman Fountain	37° 3'17"N;7°23'24"E	7.000	9	5
	7. Gargamiz	37° 4'45"N;7°23'39"E	190.300	29	3
	8. Kef Amor	37° 5'4"N;7°19'51"E	12.500	7	210
	9. Akacha	37° 4'54"N;7°17'46"E	4.500	2	80
	10. Toughnechet	37° 4'49"N;7°9'44.1"E	3.700	5	95

The floristic inventory allowed us to ascertain the values of the components used to quantify the heritage value of the flora, namely (1) the value of the botanical heritage based on the sum of the characteristics of the endemic flora (according to the gradient of extent), the degree of abundance, the local means of protection and degree of threat according to the International Union for Conservation of Nature (IUCN) in 2022; (2) the value and range of taxonomic distinctness (TD) according to Warwick & Clarke (1995); and (3) the value of priority conservation areas (PCA) according to Vane-Wright *et al.* (1991). The use of TD is particularly significant and justified because it appears to be less influenced by sample size than species richness or the Shannon index. In addition, TD is a univariate index more sensitive to community disturbances than species diversity. The TD range values were considered as the difference between the upper and lower limits. Consequently, higher TD values correspond to older floras and are sparsely contaminated by species with wider geographic ranges that could be incorporated into the territory during later events. In terms of PCA, TD implies that lower the values of the range of the upper and lower limits of TD indicate an older and more consolidated flora, which would maintain a high priority as a region for conservation.

Following Vane-Wright *et al.* (1991), we performed the process in the following steps. In the first cycle of the process, we selected the OGU with a higher quantity of species; those species were eliminated from the analysis. Then, the process was repeated in successive cycles with the rest of the species (the complement) that had not been included in the units already selected. When in a cycle we detected that more than one unity presented the same species as the complement, we selected the unity with the highest number of species (in total). If more than one OGU satisfied those conditions, we selected the first one. We concluded the process when all species were included in the designated OGU (complement = 0).

Results

Species richness

On the 10 islands studied, 223 species of vascular plants belonging to 167 genera and 61 families were identified in the ten islands studied. The *Asteraceae* family was the most prominent in terms of the number of species and represented 17.04% of the plants identified (i.e. 38 species), followed by the *Fabaceae* (8.41%, 21 species), and *Poaceae* with 7.17% (16 species). These three families alone represented approximately a third of the flora inventoried (Table 1).

The island of Gargamiz, Pain Sucre and Callisar islands, were the richest in species, with more than 70 species each. The island of Kef Amor and Toughnechet had only 11 and 15 species, respectively. The sets of islands were selected by accounting for the area effect (i.e. large islands are home to more species than small islands) and the distance effect (i.e. islands farther from the continent tend to have fewer species than closer islands with similar characteristics). Our comparison of

the area and the number of taxa thus corresponded to a potential distribution.

Biogeographic types

The study area revealed an exceptionally rich array of flora from a biogeographical standpoint:

- First, the Mediterranean set: this set was dominated by 152 species, or 68.16% of the flora listed, 120 of which contribute to the Mediterranean connecting element (*sensu stricto*), 17 to the Eury-Mediterranean connecting element and 14 to the Atlantic Mediterranean connecting element.
- The wide distribution set (i.e. cosmopolitan taxa): this set included 19 species, or 8.52% of the flora of the islands.
- The Holarctic set: the species in this set represented 3.13% of the flora studied. The paleotemperate element was represented by four taxa, followed by the Holarctic element with two taxa. The Eurasian element was represented by only one taxon and finally two taxa of tropical origin.
- The set of introduced species: this set included 17 species; introduced species occupied an especially important place in the flora on the Island of France.
- The endemic set: it comprises 29 species (13%); of particular interest was the presence of four species endemic to Algeria. Endemic plants were also well represented on the islands of the Edough Peninsula (i.e. 23 species), with 16 species having been recorded on the island of Pain Sucre. On the islands of El Kala, we recorded 17 species, five of which are closely localised to the region (*Andryala nigricans* Poir., *Armeria mauritanica* Wallr., *Rouya polygama*, *Sideritis romana* subsp. *numidica* Batt. and *Pistorinia breviflora* subsp. *breviflora*).

Botanical heritage

Among the spermatophytes identified, 48 heritages, endemic, rare, and protected heritage species, were found on the Numidian islands. Six of these taxa were heavily localised on the island of Pain Sucre. Although some plants in the study area are rare at the national scale, they are common locally, including *Stachys marrubiifolia*, because of the humid, mild climate (Appendix 1).

Two heritage plants not previously reported in Algeria were discovered during our field work: *Allium porrum* subsp. *polyanthum* and *Malva arborea* (L.) Webb & Berthel.

The IUCN Red List of Rare and Threatened Plants (IUCN, 2022) includes three plants found at our stations: *Brassica insularis* Moris, *Linaria flava* (Poir.) Desf. and *Daucus rouyi* Spalik & Reduron. At the national conservation level, six species (*Andryala nigricans*, *Euphorbia dendroides*, *Limonium spathulatum* subsp. *spathulatum*, *Limonium virgatum*, *Lotus drepanocarpus* and *Silene sedoides*) are protected by the Algerian law for the conservation of spontaneous plant species (Anon., 2012). The calculated heritage value of each taxon is shown in Table 2.

Table 2. Heritage values of each taxon according to the values of endemism, rarity, legality and threat category. Abbreviations are: END VAL, Endemic value, RA VAL, Rarity value, LEG VAL, Legal value, IUCN VAL, IUCN Value.

TAXON	END VAL	RAR VAL	LEG VAL	IUCN VAL	TAXON HERITAGE VALUE
Aba	1	2	0	0	0.6
Abj	0	3	0	0	0.6
Ala	2	4	0	0	1.2
Amr	0	3	0	0	0.6
Amu	3	1	0	0	0.8
Ani	3	3	1	0	2.2
App	0	3	0	0	0.6
Ase	0	3	0	0	0.6
Bfr	5	4	0	0	1.8
Bin	1	4	0	1	2
Bpr	4	2	0	0	1.2
Cpa	4	4	0	0	1.6
Csb	3	3	0	0	1.2
Dnu	2	2	0	0	0.8
Dsy	5	3	0	0	1.6
Eae	0	3	0	0	0.6
Ede	0	3	1	0	1.6
Fbi	0	3	0	0	0.6
Gff	4	2	0	0	1.2
Gmu	4	5	0	0	1.8
Gnn	5	2	0	0	1.4
Iun	4	2	0	0	1.2
Lde	4	3	1	0	2.4
Lfl	0	3	0	1	1.6
Lfr	5	5	0	0	2
Lss	2	3	1	0	2
Lvi	0	3	1	0	1.6
Mar	0	3	0	0	0.6
Mii	0	4	0	0	0.8
Pbb	2	4	0	0	1.2
Ptc	1	3	0	0	0.8
Rac	1	2	0	0	0.6
Rli	0	3	0	0	0.6
Sag	0	3	0	0	0.6
Sat	4	1	0	0	1
Sfa	4	4	0	0	1.6
Smi	1	3	0	0	0.8
Spr	1	3	0	0	0.8
Srn	3	4	0	0	1.4
Sse	0	4	1	0	1.8
Stu	4	3	0	0	1.4
Tfr	0	3	0	0	0.6
Tma	0	3	0	0	0.6
Vmu	0	3	0	0	0.6

Floristic similarity between the islands studied

Figure 2 illustrates the results of our OGU similarity and grouping analysis. Using the phenonic line with a similarity percentage of 89.9%, we divided three large

operational biogeographic units (OBU), separated by strong biological boundaries: a western OBU A (OGUs 8, 9 and 10), a central OBU B (OGUs 1, 2, 3 and 4) and a central OBU C (OGUs 5, 6 and 7).

Bray & Curtis Similarity Matrix (DOUBLE STANDARDIZATION)

	OGU01	OGU02	OGU03	OGU04	OGU05	OGU06	OGU07	OGU08	OGU09	OGU10
OGU01	1	0.9286	0.9039	0.9203	0.8933	0.8952	0.873	0.8933	0.9003	0.8974
OGU02	0.9286	1	0.8955	0.9053	0.896	0.9091	0.8795	0.881	0.8847	0.8817
OGU03	0.9039	0.8955	1	0.9031	0.8931	0.8949	0.8778	0.8996	0.9011	0.9006
OGU04	0.9203	0.9053	0.9031	1	0.8957	0.8924	0.8816	0.907	0.9115	0.9104
OGU05	0.8933	0.896	0.8931	0.8957	1	0.9011	0.8969	0.8846	0.8857	0.8891
OGU06	0.8952	0.9091	0.8949	0.8924	0.9011	1	0.9009	0.8842	0.893	0.8912
OGU07	0.873	0.8795	0.8778	0.8816	0.8969	0.9009	1	0.8731	0.8764	0.8745
OGU08	0.8933	0.881	0.8996	0.907	0.8846	0.8842	0.8731	1	0.9396	0.9561
OGU09	0.9003	0.8847	0.9011	0.9115	0.8857	0.893	0.8764	0.9396	1	0.9462
OGU10	0.8974	0.8817	0.9006	0.9104	0.8891	0.8912	0.8745	0.9561	0.9462	1

BIOLOGICAL BORDER	
<88%	VERY STRONG
88%-89.9%	STRONG
90%-92.9%	MODERATE
>93%	WEAK

A

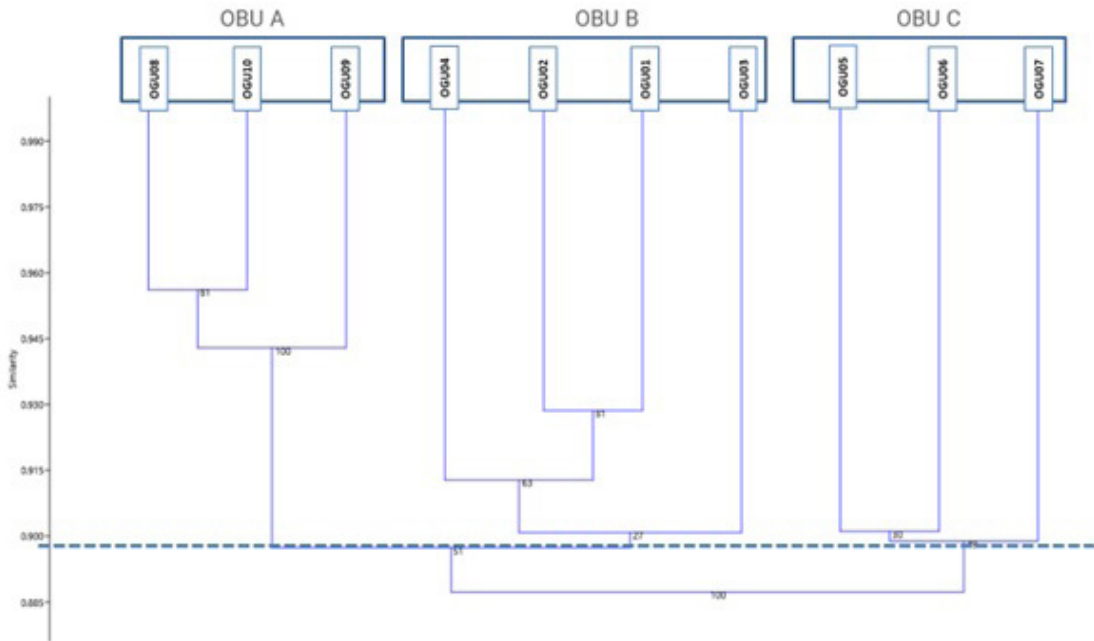

B

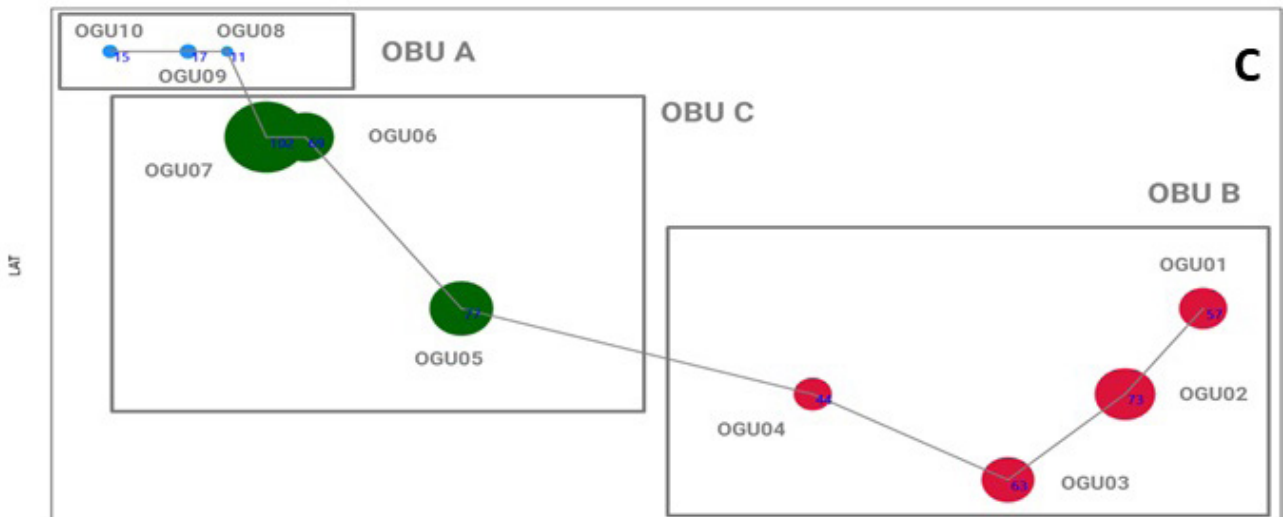

C

Figure 2. A. Bray & Curtis similarity matrix resulting from the double standardization of the basic data matrix (MBD). The gradient of biological boundaries is identified by colors based on the quartile distribution of the values. B: Clustering dendrogram obtained by the Bray & Curtis method and represented by the UPGMA algorithm (Correlation coefficient: 0.883; resampling: 1000). C: Representation by means of a bubble graph of the number of taxa per island, according to their longitudinal and latitudinal distribution, as well as the constitution of operational biogeographic units (OBU) thanks to the results of the grouping analysis which is deduced of the dendrogram.

Recognition of corotypes

Our analysis using the “r” mode in MBD allowed us to recognise eight large corotypes (see Table 3). Table 4 lists

the results as percentages of each corotypes representation in each OGU and highlights those which were used to characterise them by their high percentage of representation, in many cases, containing one or more corotypes in their

entirety. The heritage value of the corotypes was determined and visualised graphically for analysis (Figure 3).

The analysis of the composition of the flora, characterising the four groups identified statistically in CCA, suggested that each grouping is formed by plants specifically adapted to the edaphic characteristics and the degree of insularity.

Group 1 includes halo-nitrophilic plants from islands far removed from the continent with steep escarpments and acidic and saline soils. Such vegetation is linked to the presence of yellow-legged gulls and other seabirds that inhabit those areas as nesting sites or as roosts or rests. The increase of the electrical conductivity at the ground level of the three islands (Kef Amor, Akacha and Toughnechet) may be related to guano deposits and sea spray. We also observed that gulls are responsible for almost all of the high levels of nitrate and salinity of the soils carried by their plumage.

Group 2 represents the halophilic or semi-halophilic vegetation localised on the earthy slopes, particularly the cool, hyper-ventilated corridors and the ledges of the seaside, where the depth of the soil and the atmospheric humidity induced by the spray allow the development of a dense herbaceous layer of annual and perennial species. Those species exhibit a rapid growth rate, high seed production, an annual or biennial life cycle and robust development under extreme conditions.

Group 3 comprises thermophilic vegetation. This formation, where *Chamaerops humilis* is very irregular and fragmented, is subject to a more or less strong influence from the sea. At the same time, plants in the group grow on productive, relatively stable soils and seem to escape maritime influence. The presence of *Ampelodesmos mauritanicus* also favours a micro-habitat for certain

species, especially perennials (*Ambrosinia bassii*, *Artemisia arborescens*, *Arum italicum* and *Lotus cytisoides*).

Group 4 contains the vegetation of the lower part of the islands, which are regularly exposed to the action of sea spray and are home to a paucispecific community characterised by *Plantago macrorrhiza*, *Limonium fradinianum* and *Crithmum maritimum*.

Individualisation of plant groups via Canonical Correspondence Analysis according to the environmental variables

The variables represented on the positive part of axis 1 of the CCA (supporting 55.05% of information) were: remoteness from the continent, nitrate level and electrical conductivity. Those variables were allocated at the opposite of the island's surface variables on the negative side of the same axis. The plant species with a strong contribution to the positive side of the axis are: *Mesembryanthemum nodiflorum* L., *Erigeron bonariensis* L., *Spergula arvensis* L. and *Atriplex patula* L. (Figure 4). By contrast, the negative side of this axis showed the presence of: *Trifolium campestre* Schreb., *Tetragonolobus biflorus*, *Trifolium repens* L., *Stachys marrubiiifolia* Viv., *Vicia altissima* Desf. and *Cerinthemajor* L. The variable of altitude was positively correlated with axis 2, with a correlation coefficient of -1.78, and turned out to be opposed to the variables of pH and organic matter, negatively correlated with the axis ($r = -0.55$ and $r = -0.77$, respectively). Four plant communities were identified according to the evolution of environmental variables. Groups (1 and 2) showed a strong correlation with axis 1, and Group 1 was opposed to Group 2 along the same axis. Meanwhile, Groups 3 and 4 were strongly correlated with axis 2 of the CCA.

Table 3. Floristic set for each of the differentiated corotypes (the abbreviations of the taxa correspond to Table 1).

Chorotypes							
A	B	C	D	E	F	G	H
Aal	Aba	Ain	Ala	Abj	Dsy	Aar	Aas
Apa	Ama	Cel	Bbi	Amu	Fco	Ase	Aab
Acy	Ars	Cec	Bfr	Cna	Flu	Aau	Cre
Cmu	Ast	Epa	Bin	Cca	Fce	Alv	Cmj
Csu	Bpr	Epe	Cpa	Eae	Gnn	Cmt	Cfl
Dvi	Cdi	Etr	Edi	Fbi	Hpe	Eex	Dgn
Ebo	Cat	Gte	Ede	Hpo	Hhi	Lvi	Hrd
Gro	Dco	Gse	Fca	Mii	Hac	Pmt	Lcc
Gfl	Epl	Hpe	Lau	Ofi	Omi	Rrb	Mmi
Hcu	Fgr	Iun	Mti	Pbb	Sas	Sse	Tma
Hal	Gmu	Lcl	Sat	Pla	Ste	Sol	Upl
Jma	Lre	Ope	Stu	Rge	Tbi	Thi	Val
Mtr	Min	Obo	Spr	Rhy	Tca		
Ost	Psa	Osp	Sfa	Sni			
Sbo	Paa	Ott	Tfr	Sag			
Sli	Pav	Ppi					
Ssq	Rul	Rac					
Tga	Rbc	Sbu					
Tdi	Sco						
Xst	Soc						

Table 4. Percentage of representation of each corotype in each OGU. In yellow, the values which are highlighted which serve to characterize each OGU by virtue of the strong representation of the corotypes and their exclusivity.

Corotype	Nº tax Corotype	OGU01	OGU02	OGU03	OGU04	OGU05	OGU06	OGU07	OGU08	OGU09	OGU10
Corotype A	20	0	0	100	0	0	0	0	0	0	0
Corotype B	20	5	0	20	0	40	100	100	0	0	0
Corotype C	17	0	0	0	0	6	0	100	0	0	0
Corotype D	15	0	0	0	0	100	0	0	0	0	0
Corotype E	15	33	27	7	93	20	0	20	0	0	0
Corotype F	12	0	17	17	0	100	0	100	0	0	0
Corotype G	12	100	100	33	0	8	8	17	0	0	0
Corotype H	12	0	0	0	0	8	100	0	0	0	0

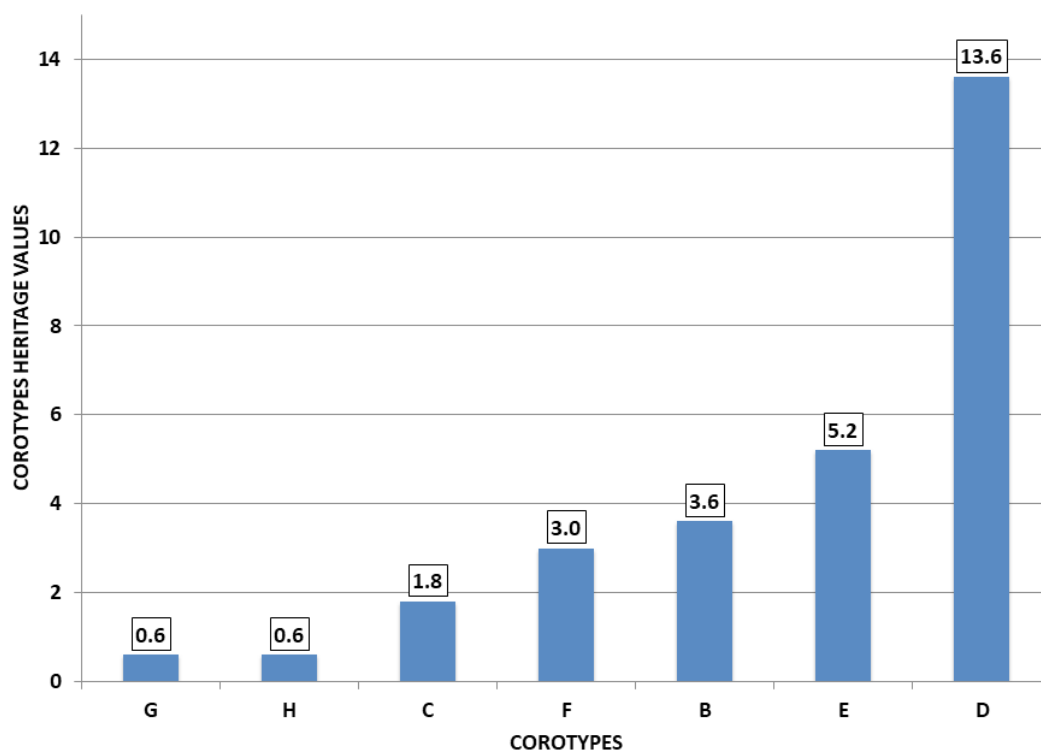

Figure 3. Accumulated heritage value of each corotype as a function of the heritage value of the species that compose it.

Taxonomic distinctness (TD)

The analysis of the TD (Figure 5) showed that the most archaic and most interesting flora from a conservationist standpoint were those corresponding to OGU 07 (island of Gargamiz) as well as three of the four OGU of OBU B corresponding to the eastern-most islands. By contrast, the ranking of TD for each island revealed that the western-most islands (OBU A) had less stabilised flora and are therefore open to plans for floristic restoration. The UBO B and C had more stabilised flora and require specific preservation plans to preserve heritage values.

Priority Conservation Areas (PCAs)

The distribution of the normalised values of the PCA (total of the species in each cycle is divided by the total of the species in the target area) was contrasted or opposed to those of TD ranking, meaning that they were distributed in the same way in the two potential adjustments (Figure 6). The prioritisation sequence for the conservation of areas is high in the cases OGU 07 (Gargamiz) and OUG05 (Pain Sucre), and of moderate nature in OUG01 (Boutribicha), OUG02 (Callisar), OUG03 (Island of France), and OUG06 (Roman Fountain).

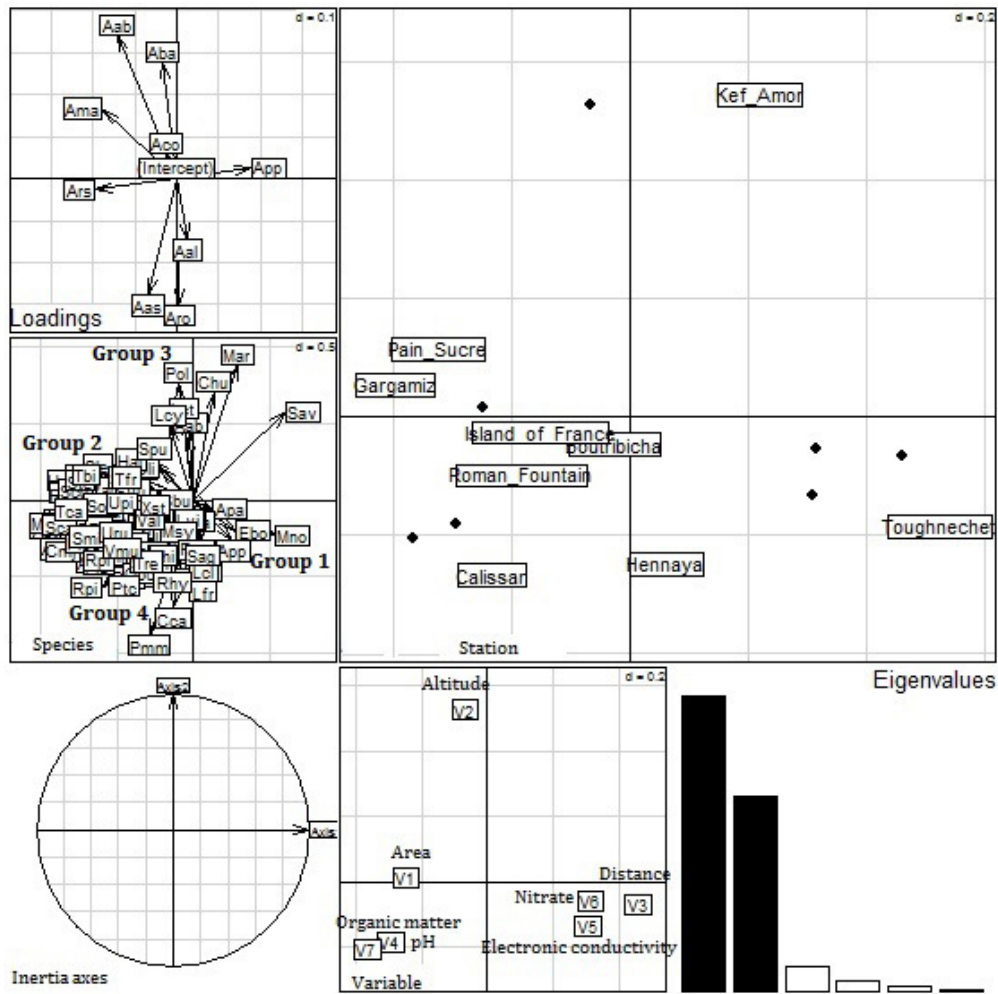

Figure 4. Canonical Correspondence Analysis map 10 islands x 223 species x 7 environmental variables

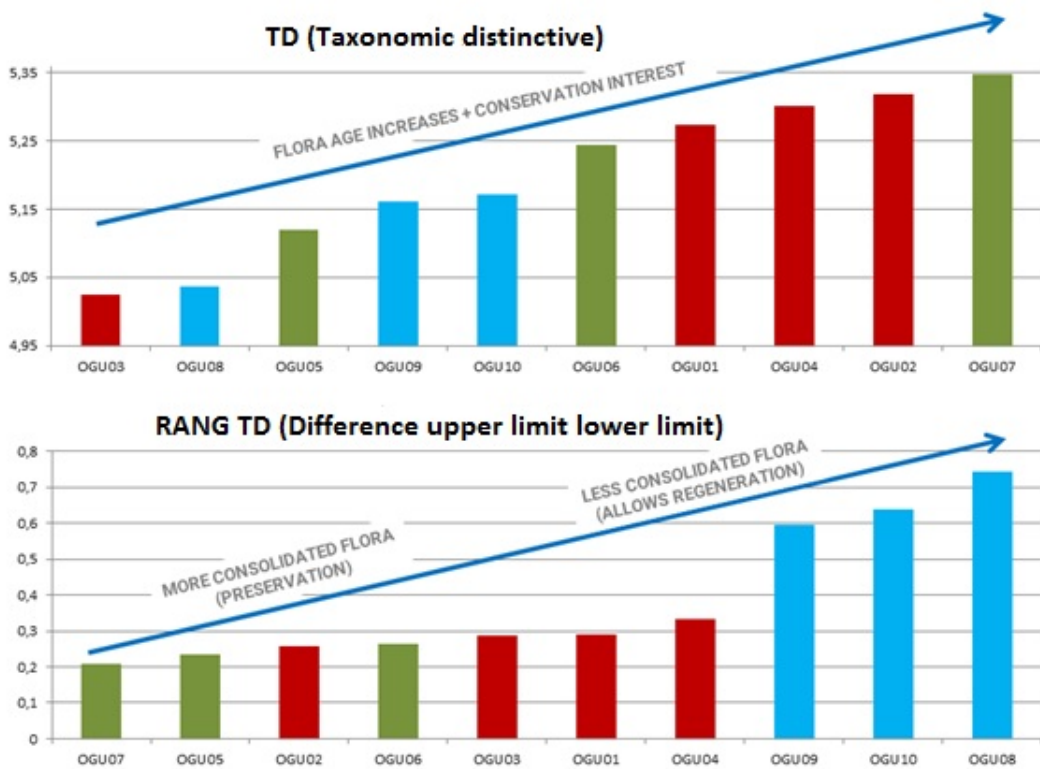

Figure 5. Bar chart of TD (top) and TD (bottom) ranks sorted in ascending order

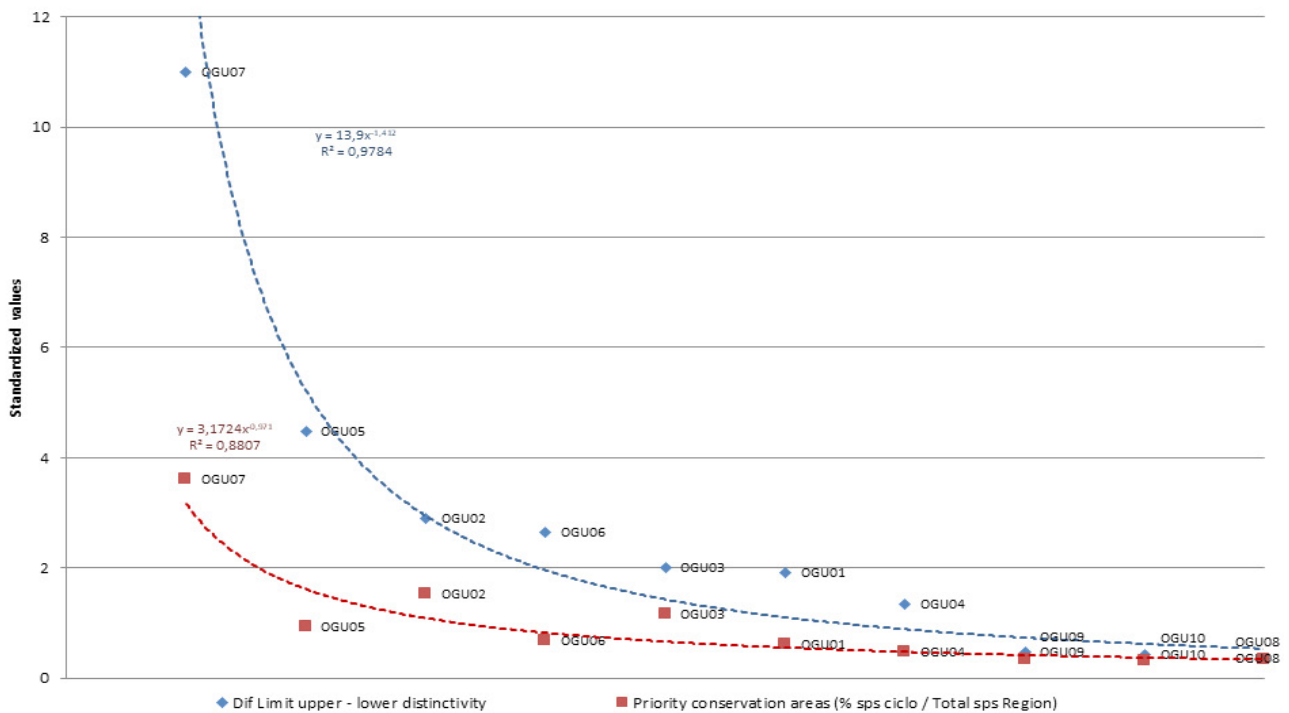

Figure 6. The potential distribution of the values of the TD and PCA range

Discussion

Floristic, biological and biogeographic diversity

The floristic composition of the studied area shows the existence of 223 species. Those species constitute an array of flora characteristic of Mediterranean islands, that is relatively rich compared with the variety in the Kabylia, central Algeria and western Algeria (Véla & Benhouhou, 2007; Médail & Diadéma, 2009, Bahi *et al.*, 2019).

Despite high specific richness, the floral component of the studied islands is characterised by surprising absences of common, if not very common, taxa that structure the maquis of Africa's north-western coast (Numidian coast) (Hamel, 2013; Hamel & Boulemtafes, 2017; Boulemtafes *et al.*, 2018), including: *Cistus monspeliensis*, *Cistus salvifolius*, *Phillyrea latifolia*, *Thymelaea hirsuta*, *Anthyllis barba-jovis*, etc. Those absences or extreme scarcities can be explained by the environmental and biological constraints linked to insularity, including more difficult and hazardous colonization, small populations, and different biotic interactions (Médail & Vidal, 1998).

At the same time, the flora studied is dominated by therophytes. Those species characterise the Mediterranean region and arid areas with strong water stress (Raunkiaer, 1934). Daget (1980) considers the phenomenon of therophytes to be an adaptative strategy to Mediterranean climatic rigours, particularly summer drought (Madon & Médail, 1997).

Despite the dominance of therophytes, hemicryptophytes are important in the studied area. Therophytes and hemicryptophytes are considered to be particularly adapted to strong regimes of intense disturbance (Médail & Vidal, 1998) and the stresses of the Mediterranean bioclimate (Hobbs & Mooney, 1995).

Our examination of the major chorological types encountered in the study area confirms the dominance of the Mediterranean element (68.16%), a fact highlighted by Quézel (2002) for all the countries in North Africa. In addition, among the flora studied, northern species were sparsely distributed over a wide area. Most of those species would probably have settled in favour of a humid and cool climate corresponding to the Pleistocene glacial phases. The plants whose installation dates back to preglacial periods, notably the Pliocene, have practically disappeared, apart from a few remains (Quézel, 1983; Quézel, 1995). Subsequent climatic changes have caused the disappearance of most of those species, and the ones that remain are currently limited to well-watered mountains and wetlands (Maire, 1928; Quézel, 1995). Mixed with the native flora, several invasive species were identified on the islands, especially on the "Island of France". But, the competitive ability of existing native species appears to decline over time and their population reduces, and sometimes indeed becomes extinct (Adsersen, 1991).

Rarity and endemism

The flora studied included 38 rare species (17.04%) according to Quézel & Santa (1962-1963). That rate shows that the islands appear as refuges for rather rare species with a fragmented range (Véla & Benhouhou 2007, Yahi *et al.*, 2012; Hamel *et al.*, 2013, Hamel & Boulemtafes 2017b). Thus, the presence of new species of Algerian flora and new stations in the eastern part of the country (Numidia, K3) constitutes a conservation priority in the area, which is regarded as a mini-hotspot or regional hotspot of plant biodiversity, called "Kabylia - Numidia - Kroumiria" (Véla & Benhouhou, 2007), an area in which many sectors have historically

been poorly surveyed (Quézel & Bounaga, 1975) and in which certain species had never been previously recorded.

Although the endemism element is limited in Algeria, the endemic species developing on the islands studied are relatively numerous, compared with the number of endemic species observed on the Edough Peninsula (31 taxa) (Hamel *et al.*, 2013). That large number might be explained by the edaphic factor, which plays a determining role in the distribution of the latter sort of species (Kruckeberg & Rabinowitz, 1985), which are largely rupicolous, linked to the absence of evolved soils or alive in very particular, hydromorphic soils (i.s. salty, sour, etc.) (Thompson *et al.*, 2005). Generally speaking, the islands in our study are very close to the continent. Qulichini (1999) has observed, by contrast, that oceanic islands, because of their utter isolation, are far richer in endemic species than the islands close to the continents, and especially if they have small surface areas. Thus, endemic species are very rare and have a restricted distribution.

Totalling eight in number, most endemic species recorded in our study are Algerian-Tunisian. These species are corresponding to a lesser extent to areas of specialised hyperendemism than to vast biogeographical areas where endemic species are locally rare, even abundant (Véla & Benhouhou 2007; Hamel & Boulemtafes, 2017c). The presence of the endemic Tyrrhenian plants (7 taxa) can be explained by the previous terrestrial connections of the Algerian Coastal tel with Tyrrhenia (Quézel, 1964). Thus, the biogeographical interest in the studied islands lies in the number of species strictly endemic to Algeria (4 taxa), the presence of which depends heavily on the substrate (Hamel *et al.*, 2013; Boulemtafes *et al.*, 2018).

The rate of the rarity of endemic species that we identified is remarkable (60.71% or 17 taxa). In fact, more than three-quarters (77.9%) of strictly endemic Algerian or sub-endemic taxa are rare plants (Quézel & Santa, 1962-1963), with the more or less common endemic species representing less than a quarter of the total (Véla & Benhouhou, 2007).

Due to a lack of documentation and sufficient studies and apart from aquatic and semi-aquatic species (Quézel, 1964), most endemic plants on the islands have not yet been evaluated according to the IUCN criteria (IUCN, 2022) and many of them do not have national protection status either, because the JORA list (2012) is incomplete and has not been revised according to the new criteria. In addition, several species have found unique habitats on the Edough peninsula in Algeria (Quézel & Santa, 1962-1963), including *Brassica insularis*, *Centaurea papposa*, *Seseli praecox* and *Brassica fruticulosa* subsp. *numidica*. The last of these is classified as determinant species in the IPA classification "Edough Peninsula", and appears in a restricted area (occurrence about 100 km²). Three taxa (*Limonium spathulatum* subsp. *spathulatum*, *Lotus drepanocarpus* and *Sixalix farinosa* have a threshold of occurrence of 5000 km² (Yahi *et al.*, 2012).

Influence of environmental variables on the flora richness of islands

The Sørensen coefficient yielded values greater than 17.88% (17.88% to 63.38%), meaning that the similarity in the vascular flora of the two islands taken in pairs may differ in their floristic composition. In fact, only 22 species were recorded more than five times at the ten sites studied, which means that the floristic interdependence between the islands is important. Moreover, 81 species were recorded only on one of the ten islands studied. As a result, many are characteristic and/or rare species.

According to the similarity coefficient, floristic independence seems to be most significant on the smallest islands studied. Panitsa & Tzanoudakis (2001) maintain that even species that seem to be well-adapted to small islets show an uneven distribution in the Mediterranean region.

In our study, the species richness of islands depended above all on certain physicochemical parameters of the soil and the degree of insularity. Those trends can be explained by the similarity coefficient that was close to 1. At the same time, 73% of the floristic variability can be explained by five variables. Our data show that islands with high seabird densities coincide with high nitrate levels. There are islands where richness can be greater with equal or smaller surfaces as we observed on two islands: El Kala (Callisar island) (17288 m² and with 73 species) and the Island of France (22942 m² with 63 taxa). The same is true for the islands of the Edough Peninsula (Akacha Island with 4500m² and 17 taxa and Kef Amor Island with 12500 m² and 15 taxa). Those differences can be attributed to the type of substratum, the general physiognomy, the nature of the relief, the presence of rocks, and/or the different existing groups (Gamisans & Paradis 1992).

The present study used CCA to relate species abundance to environmental variables (Marre 1992). Because assemblies of species result from the complex interplay of many historical and evolutionary factors, it is particularly important to isolate one of those factors when it manifests as a continuous gradient (Tassin & Rivière, 2003). In Group 1, which included halonitrophilic plants from islands far removed from the continent, results agreed with those observed by Abbott *et al.* (2000) and García *et al.* (2002), who reported the presence of halophilic species, *Mesembryanthemum nodiflorum*, *Spergula arvensis* and *Atriplex patula* capable of concentrating salt in their tissues and increasing soil salinity. The relative acidification observed in soils most subject to the action of gulls is also observed in most seabird colonies (Mulder *et al.* 2011). Groups 2-4 were formed by plants specifically adapted to the edaphic characteristics and insularity condition.

Last, our results concerning the island plant communities of Numidia agree with the results obtained on the Algerian coast (Benhamiche-Hanifi & Moulai, 2012), the Tunisian coast (Médail & Véla, 2020) and the southern shores of the Mediterranean Sea (Paradis

et al., 1994; Murguía & Rojas 2010; Médail *et al.*, 2015; Paradis & Pozzo di Borgo, 2015; Médail *et al.*, 2017).

Conclusion

The present study has demonstrated that the combined analysis of TD and the selection of priority conservation areas are useful for enhancing the diversity of flora with heritage value and the prioritization of the protection of spaces within land-use plans in accordance with SDG 15.

The method adopted was based on the quantitative biogeography of islands, elucidating the need to combat the erosion of the biodiversity of the vascular flora of the Algerian coast. The coast is particularly important in the Mediterranean Sea, where the island flora makes the region a biological hotspot.

Such a finding can be explained by the presence of numerous plants having heritage value (rare, endemic or threatened taxa), and by the originality in the floral composition of the island population. The islands possess a strong total floristic wealth, exceeding that of islands with identical and sometimes larger areas. This exceptional heritage urgently needs to be protected from the risk of disappearance linked to unrelenting tourist activity, urbanization (i.e. on the Island of France) and the invasion of xenophytic plants.

Author contribution

T.H.: Conceptualization, Data curation, Management of the project, Research, Writing; N.H.T.: Conceptualization, Data curation, Writing; A.M.H.: Research, Writing; A.B.: Research; N.S.: Writing; G.B.: Methodology, Research, Writing; Á.E.S.T.: Formal analysis, Management of the project, Writing.

Conflict of interest

None.

References

- Abbott, I., Marchant, N. & Cranfield, R. 2000. Long-term change in the floristic composition and vegetation structure of Carnac Island Western Australia. *J. Biogeogr.* 27: 333–346. doi: 10.1046/j.1365-2699.2000.00409.x
- Adersen, H. 1991. Evolution, extinction and conservation: examples from the Galapagos flora. *Evolution Trends in Plants* 5 : 9–18.
- Anonymous. 1999. AFNOR. Qualité des sols—vocabulaire. Partie 2. Termes et définitions relatifs à l'échantillonnage. Paris.
- Anonymous. 2012. Décret exécutif du 18 janvier 2012, complétant la liste des espèces végétales non cultivées et protégées. *Journal officiel de la république algérienne (J.O.R.A.)* Alger. n° 3–12/12 du 18-01-2012. 12–38.
- Bahi, K., Hadjadj Aouel, S. & Belguermi, A. 2019. Note on the Flora of Plane Island (Oran). *Ecologia mediterranea* 45(1) : 61–66.
- Benhamiche–Hanifi, S. & Moulai, R. 2012. Analyse des phytocénoses des systèmes insulaires des régions de Béjaia et de Jijel (Algérie) en présence du Goéland leucophée (*Larus michahellis*). *Revue d'Ecologie (Terre et Vie)* 67 : 375–397.
- Benhouhou, S., Yahi, N. & Véla, E. 2018. Algeria, chapter 3 Key Biodiversity Areas (KBAs) for plants in the Mediterranean region. *IUCN* 53–60.
- Blanca, G., Cabezudo, B., Cueto, M., Lopez, C.F. & Torres, C.M. 2009. *Flora Vasculare de Andalucía Oriental*, 1–4. Consejería de Medio Ambiente. Junta de Andalucía, Sevilla.
- Bougaham, A.F. & Moulai, R. 2013. Aspects démographique et chronologie d'installation des nids du Goéland leucophée (*Larus michahellis*) dans la région de Jijel (Algérie). *Lebanese Science Journal* 14 : 3–13.
- Boulemtafes, A., Hamel, T., de Bélair, G. & Véla, E. 2018. Nouvelles données sur la distribution et l'écologie de seize taxons végétaux du littoral de la péninsule de l'Edough (Nord–Est Algérien). *Bulletin de la Société Linnéenne de Provence* 69 : 59–76.
- Bouyahmed, H. & Moulai, R. 2018. Influence of the yellow-legged gull on soil, composition and organisation of plant communities on some small Islands of Algeria. *Zoology and Ecology* 28(4): 300–312. <https://doi.org/10.1080/21658005.2018.1527604>
- Bray, R.J. & Curtis, J.T. 1957. An ordination of the upland forest communities of southern Wisconsin. *Ecol. Monogr.* 27: 325–349. doi: <http://dx.doi.org/10.2307/1942268>
- Chiarucci, A., Bacaro, G., Arévalo, J. R., Delgado, J. D. & Fernández-Palacios, J. M. 2010. Additive partitioning as a tool for investigating the flora diversity in oceanic archipelagos. *Persp. Plant Ecol. Evol. Syst.* 12 : 83–91.
- Daget, P.H. 1980. Sur les types biologiques en tant que stratégie adaptative (cas des thérophytes). In: Barbault, R., Blandin, P. & Meyer, J.A. (Eds.). *Recherches d'écologie théorique: les stratégies adaptatives*. Pp. 89–114. Masson, Paris.
- Delanoë, O., Montmollin, B. & de Olivier, L. 1996. The IUCN/SCC Mediterranean Islands Plant Specialist Group—Conservation of Mediterranean Island Plants. Strategy for Action. IUCN Communications Division, Gland.
- Delauge, J. & Véla, E. 2007. Etude de la végétation des îles Habibas. In: Bachet, F., Bebhaj, S., Bernard, F., Delauge, J., Hamerlin, J., Mante, A., Pascal, M., Tillmann, M., Vela, E., Vidal, P. (Eds.). *Reserve des Îles Habibas - Notes naturalistes - Petites îles de Méditerranée-2004/2007*. Pp. 50–70. Conservatoire de l'espace littoral et des rivages lacustres, Aix-en-Provence.
- Díaz, S., Settele, J., Brondízio, E.S., Ngo, H.T., Guèze, M., Agard, J., Arneth, A., Balvanera, P., Brauman, K.A., Butchart, S.H.M., Chan, K.M.A., Garibaldi, L.A., Ichii, K., Liu, J., Subramanian, S.M., Midgley, G.F., Miloslavich, P., Molnár, Z., Obura, D., Pfaff, A., Polasky, S., Purvis, A., Razaque, J., Reyers, B., Chowdhury, R., Shin, Y.J., Visseren-Hamakers, I.J., Willis K.J. & Zayas C.N. (Eds.). 2019. Summary for policymakers of the

- global assessment report on biodiversity and ecosystem services of the Intergovernmental Science-Policy Platform on Biodiversity and Ecosystem Services. IPBES Secretariat, Bonn.
- Dobignard, A. & Chatelain, C. 2010–2013. Index synonymique de la flore d’Afrique du Nord. 5 vols. Conservatoire de jardin botanique de Geneve (C.J.B.G), Geneve. www.ville-ge.ch/musinfo/bd/cjb/africa/
- Domina, G. & Jaouadi, W. 2013. Suivi botanique de l’archipel de Zembra. Note naturaliste Initiative PIM, Aix-en-Provence, 94p.
- Domina, G. & El Mokni, R. 2012. Suivi floristique de l’archipel de Zembra et Zembretta, Tunisie. Note naturaliste Initiative PIM, Aix en Provence, 107p.
- Gamisans, J. & Paradis, G. 1992. Flore et végétation de l’île Lavezzi (Corse du S). Travaux scientifiques du Parc Naturel Régional et Réserves Naturelles de Corse 37 : 1–68.
- García, L.V., Marañón, T., Ojeda, F., Clemente, L. & Redondo, R. 2002. Seagull influence on soil properties, chenopod shrub distribution, and leaf nutrient status in semiarid Mediterranean islands. *Oikos* 98 : 75–86. doi: 10.1034/j.1600-0706.2002.980108.x
- Ghermaoui, M., Hassaine, K. & Moulai, R. 2016. Influence du Goéland leucophaé (*Larus michahellis*) sur les formations végétales ouvertes du littoral Rachgoune (ouest Oranie, Algérie). *Revue d’Ecologie (Terre et Vie)* 71 : 250–265.
- Greuter, W. 1995. Origin and peculiarities of Mediterranean island floras. *Ecologia Mediterranea* 21 : 1–10.
- Hamel, T. 2013. Contribution à l’étude de l’endémisme chez les végétaux vasculaires dans la péninsule de l’Edough (Nord–Est algérien). Thèse de Doctorat en Biologie végétale, université Badji Mokhtar Annaba, Algérie. 338p.
- Hamel, T., Seridi, R., de Bélair, G., Slimani, A.R. & Babali, B. 2013. Flore vasculaire rare et endémique de la péninsule de l’Edough (Nord–Est algérien). *Revue Synthèse des Sciences et de la Technologie* 26 : 65–74.
- Hamel, T. & Boulemtafes, A. 2017a. Floristic diversity of the cap de Garde (North–East Algeria). *IJB* 10(6) : 131–149.
- Hamel, T. & Boulemtafes, A. 2017b. Nouvelle station de *Sixalix farinosa* (Coss.) Greuter et Burdet dans la péninsule de l’Edough (Nord–Est algérien). *Bulletin de la Société Linnéenne de Provence* 68 : 93–100.
- Hamel, T. & Boulemtafes, A. 2017c. Découverte d’une endémique tyrrhénienne *Soleirolia soleirolii* (Urticaceae) en Algérie (Afrique du Nord). *Flora Mediterranea* 27: 185–193. doi: 10.7320/FIMedit27.185
- Hammer, Ø. 2019. PAST, PAleontological Statistics. Version 3.25. Reference manual. Natural History Museum, University of Oslo. <https://folk.uio.no/ohammer/past/past3manual.pdf>
- Hobbs, R.J. & Mooney, H.A. 1995. Effects of episodic rain events on Mediterranean climate ecosystems. In: Roy, J., Aronson, J. & Di Castri, F. (Eds.). Time scales of biological responses to water constraints. Pp. 71–85. SPB Academic Publishing, Amsterdam.
- Höner, D. & Greuter, W. 1988. Plant population dynamics and species turnover on small islands near Karpathos (South Aegean, Greece). *Vegetation* 77: 129–137.
- Jain, A.K. 2009. Data clustering: 50 years beyond K-means. *Pattern Recogn. Let.* 31(8) :651–666. doi: 10.1016/j.patrec.2009.09.011.
- Kruckeberg, A. R. & Rabinowitz, I. 1985. Biological aspects of endemism in higher plants. *Annu. Rev. Ecol. Evol. Syst.* 16: 447–479.
- Likas, A., Vlassis, N. & Verbeek, J.J. 2003. The global k-means clustering algorithm. *Pattern Recogn. Let.* 36(2): 451–461. <https://hal.inria.fr/inria-00321515/document>
- Madon, O. & Médail, F. 1997. The ecological significance of annuals on a Mediterranean grassland (Mt Ventoux, France). *Plant Ecol.* 129 : 189–199. doi: 10.1023/a:1009759730000
- Maire R. 1928. Origine de la flore des montagnes de l’Afrique du Nord. *Mémoire Société de Biogéographie* 2 : 187–194.
- Maire, R. 1952–1987. Flore de l’Afrique du Nord (Maroc, Algérie, Tunisie, Tripolitaine, Cyrénaïque et Sahara), 16 vols. Lechevalier, Paris.
- Marre, A. 1992. Le Tell oriental algérien de Collo à la frontière tunisienne, étude géomorphologique. Office des Publications Universitaires OPU, 1. Alger. 177p.
- Mathieu, C. & Pieltain, F. 2003. Analyse chimique des sols. Edition Technique et Médical. Lavoisier, Paris.
- Médail, F. & Diadéma, K. 2009. Glacial refugia influence plant diversity patterns in the Mediterranean Basin. *J. Biogeogr.* 36: 1333–1345. doi: 10.1111/j.1365-2699.2008.02051.x
- Médail, F. & Quézel, P. 1997. Hot-spots analysis for conservation of plant biodiversity in the Mediterranean basin. *Ann. Mo. Bot. Gard.* 84 : 112–127.
- Médail, F. & Vidal, E. 1998. Organisation de la richesse et de la composition floristique d’îles de la Méditerranée occidentale (sud-est de la France). *Can. J. Botany* 76: 321–331. doi: 10.1139/b97-135
- Médail, F. and Véla, E. 2020. Flore et végétation vasculaires de l’archipel de Zembra (Tunisie nord–orientale). Note naturaliste PIM, Marseille. 84p.
- Médail, F. & Myers, N. 2004. Mediterranean Basin. In: Mittermeier, R.A., Robles Gil, P., Hoffmann, M., Pilgrim, J., Brooks, T., Mittermeier, C.G., Lamoreux, J. & da Fonseca, G.A.B. (Eds.), Hotspots revisited: Earth’s Biologically Richest and Most Endangered Terrestrial Ecoregions. Pp. 144–147. CEMEX. MonterreyConservation International, Agrupación Sierra Madre, Mexico.
- Médail, F., Pavon, D. & Diadéma, K. 2015. Flore et végétation vasculaires terrestres de l’île Saint–Honorat (archipel de Lérins, Cannes, Alpes–Maritimes). *J. Bot.* 69 : 3–32.
- Médail, F., Petit, Y., Ponel, P., Faggio, G. & Rist, D. 2015. Biodiversité terrestre des îles et îlots satellites du littoral de Galeria à Porto (Corse occidentale). Note naturaliste PIM, Aix–en–Provence. 71p.
- Médail, M., Petit, Y., Delage, A., Paradis, A. & Hugot, L. 2017. La flore vasculaire de l’île de Cavallo (archipel des Lavezzi, Corse): diversité, intérêt biogéographique

- et conservation. *Ecologia Mediterranea* 43(2): 103–158. doi: 10.3406/ecmed.2017.2020
- Montmollin, B. & de Strahm, W. 2010. The Top 50 Mediterranean Island Plants: Wild plants at the brink of extinction, and what is needed to save them. IUCN/SSC Mediterranean Islands Plant Specialist Group. IUCN. Gland, Cambridge. 123 p.
- Mulder, C.P.H., Anderson, W.B., Towns, D.R. & Bellingham, P.J. 2011. *Seabird Islands: Ecology, invasion, and restoration*. Oxford University Press, New York. 512p.
- Murguía, M. & Rojas S.F. 2010. Biogeografía cuantitativa. In: J. Llorente Bousquets and Morrone, J.J. (Eds.) *Introducción a la biogeografía en Latinoamérica: teorías, conceptos, métodos y aplicaciones*. Las Prensas de Ciencias, Facultad de Ciencias, UNAM, México.
- Panitsa, M. & Tzanoudakis, D. 2001. A Floristic Investigation of the Islet Groups Arki and Lipsi, (East Aegean Area, Greece). *Folia Geobot.* 36: 265–279. doi: 10.1007/BF02803180
- Paradis, G. & Pozzo di Borgo, M.L. 2015. Phytosociologie et symphytosociologie de l'île Lavezzi (Réserve naturelle des Bouches-de-Bonifacio, Corse). Contribution à l'étude de la dynamique de la végétation de l'île depuis la suppression du pacage. *Evaxiana* 1 : 113–230.
- Paradis, G., Lorenzoni, C. & Piazza, C. 1994. Flore et végétation de l'île Piana (Réserve des Lavezzi, Corse du Sud). *Travaux scientifiques du Parc Naturel Régional et Réserves Naturelles de Corse* 50 : 1–87.
- Passetti, A., Aboucaya, A., Buisson, E., Gauthier, J., Médail, F., Pascal, M., Ponel, P. & Vidal, E. 2012. Restauration écologique de la Réserve intégrale de l'île de Bagaud. *Scientific Reports of Port-Cros National Park* 26 : 149–171.
- Pignatti, S. 1982. reprint 1997. *Flora d'Italia*. Bologna (IT), Edagricole, 3 vols, 780 p.
- Quézel, P. & Bounaga, D. 1975. Aperçu sur la connaissance actuelle de la flore d'Algérie et de Tunisie. *Colloque international de Centre National de la recherche scientifique* 235 : 113–125.
- Quézel, P. & Santa, S. 1962–1963. *Nouvelle flore de l'Algérie et des régions désertiques méridionales*. 2 tomes. Centre national de la recherche scientifique, Paris.
- Quézel, P. 1964. L'endémisme dans la flore d'Algérie. *Comptes rendus de la Société de Biogéographie* 361 : 137–149.
- Quézel, P. 1983. Flore et végétation actuelles de l'Afrique du Nord, leurs significations en fonction de l'origine, de l'évolution et des migrations des flores et structures de végétation passées. *Bothalia* 14 : 411–416.
- Quézel, P. 1995. La flore du bassin Méditerranéen: origine, mise en place, endémisme. *Ecologia Mediterranea* 21 : 19–39.
- Quézel, P. 2002. Réflexions sur l'évolution de la flore et de la végétation au Maghreb Méditerranéen. Ibis Press, Paris. 74p.
- Qulichini, A. 1999. Biologie et conservation d'une espèce endémique corso-sarde rare et protégée: *Anchusa crispa* Viv. (Boraginaceae). Implication pour la conservation. Thèse de Doctorat en Biologie des populations et écologie, Université de Corse, France. 217p.
- Raunkiaer, C. 1934. *The life forms of plants and statistical plant*. Oxford University Press., London.
- Salvo Tierra, Á.E. & García-Verdugo, J.C. 1988. Biogeografía numérica en pteridología. *Taxonomía, biogeografía y conservación de pteridófitos* (J. Rita, Ed.). *Monografías de la Societat d'Història Natural de les Balears* 1: 115–149. Palma de Mallorca.
- Salvo Tierra, Á.E. & Melero-Jiménez, I., García-Sánchez, J. & Báez, J.C. & Flores-Moya, A. 2020. Biogeografía analítica de la pteridoflora del Arco de Alborán: consecuencias para su status de protección. *Acta Botanica Malacitana* 45: 1–19. doi: 10.24310/abm.v45i0.7743
- Salvo Tierra, Á.E., Báez, J.C. & Flores-Moya, A. 2021. The historical biogeography and conservation value of taxonomic distinctness: The case of ferns flora of the Gibraltar Arc. *Bot. Compl.* 45, e75454. doi : 10.5209/bocm.75454.
- Seltzer, P. 1946. *Le climat de l'Algérie*. La Typo-Litho, Alger.
- Tassin, J. & Rivière, J.N. 2003. Gradient altitudinal de richesse en plantes invasives à l'île de La Réunion (Archipel des Mascareignes, Océan Indien). *Revue d'Ecologie (Terre et Vie)* 58 : 257–270.
- Ter Braak, C.J.F. 1995. Ordination: Data analysis in community and landscape ecology. In: Jongman R. H. G., Ter Braak C.J.F. & Van Tongeren O.F.R. (Eds.). *Ordination: Data analysis in community and landscape ecology*. Pp. 91–173. Cambridge Univ. Press, Cambridge.
- Thompson, J.D., Lavergne, S., Affre, L., Gaudeul, M. & Debussche, M. 2005. Ecological differentiation of Mediterranean endemic plants. *Taxon* 54(4): 967–976. doi: 10.2307/25065481
- Tison, J. M. & de Foucault, B. 2014. *Flora gallica: flore de France*. Mèze, Biotope. 1196p.
- Vane-Wright, R. I., Humphries, C.J. & Williams, P.H. 1991. What to protect? Systematics and the agony of choice. *Biol. Conserv.* 55: 235–254. doi: 10.1016/0006-3207(91)90030-D
- Véla, E. & Benhouhou, S. 2007. Evaluation d'un nouveau point chaud de biodiversité végétale dans le Bassin Méditerranéen (Afrique du Nord). *C.R. Biol.* 330 : 589–605. doi: 10.1016/j.crv.2007.04.006
- Véla, E. & Pavon, D. 2012. The vascular flora of Algerian and Tunisian small islands: if not biodiversity hotspots, at least biodiversity hotchpotchs? *Biodiversity J.* 3(4) : 343–362.
- Véla, E. 2008. Mission exploratoire à Skikda: Petites îles de Méditerranée. Conservatoire de l'espace littoral et des rivages lacustres, Aix-en-Provence, 54p.
- Véla, E. 2017. Commentaires sur la flore de l'île Rachgoun (Nord-Ouest Algérie). *Revue d'Ecologie (Terre et Vie)* 72 (3) : 258–268.
- Wang, T., Chen, X., Zheng, X., Lu, Y., Han, F. & Yang, Z. 2022. Identification of Priority Conservation Areas for Natural Heritage Sites Integrating Landscape Ecological Risks and Ecosystem Services: A Case Study in the Bogda, China. *Int. J. Environ. Health Res.* 19: 20–44. doi: 10.3390/ijerph19042044

- Warwick, R.M. & Clarke, K.R. 1995. New 'biodiversity' measures reveal a decrease in taxonomic distinctness with increasing stress. *Marine Ecology Progress Series* 129: 301–305. doi: 10.3354/meps129301
- Whitehead, D.R. & Jones, C.E. 1969. Small islands and the equilibrium theory of insular biogeography. *Evolution* 23 : 171–179.
- Yahi, N., Véla, E., Benhouhou, S., de Bélair, G. & Gharzouli, R. 2012. Identifying important plants areas (key biodiversity areas for plants) in northern Algeria. *J. Threat. Taxa* 4 : 2453–2765. doi : 10.11609/JoTT. o2998.2753–65.

Websites

- APD. 2022. African Plants Database. Geneva: Conservatoire et Jardin botaniques de la Ville de Genève; Pretoria (SA): South African, South African National Biodiversity Institute) [http:// www.ville-ge.ch/musinfo/bd/cjb/africa](http://www.ville-ge.ch/musinfo/bd/cjb/africa).
- IUCN. 2022. IUCN Red List of Threatened Plants. Version 2022–1. Available online at: <https://www.iucnredlist.org/>
- R Development Core Team. 2013. R: A language and environment for statistical computing. R Foundation for statistical computing, Vienna, Austria. <http://www.R-project.org>.

Appendix 1. Systematic list of species inventoried in the ten islands studied. Abbreviations are: BT: Biological type (Th: Therophyte, He: Hemicytrophite, Ph: Phanerophyte, Ge: Geophyte, Ch: Chamaephyte); BD: Biogeographical distribution (End: Endemic, Alg: Algeria, Tun: Tunisia, Mor: Morocco, Lib: Libya, Spa: Spain); Sc: Scarcity (FC: fairly common, R: rare, VR: very rare, * modified rarity); IU: IUCN (2022, NT: near threatened); JO: JORA(2012, P: protected); Localities: 1: Boutribicha, 2: Callisar, 3: Island of France, 4: Hennaya, 5: Pain Sucre, 6: Roman Fountain, 7: Gargamiz, 8: Kef Amor, 9: Akacha, 10: Toughnechet.

Code	Taxon	Family	BT	BD	Sc	IU	JO	1	2	3	4	5	6	7	8	9	10
Aas	<i>Achyranthes aspera</i>	Amaranthaceae	Ch	Tropical									x				
Aco	<i>Allium commutatum</i>	Alliaceae	Ge	Mediterranean				x									
Amu	<i>Allium multiflorum</i>	Alliaceae	Ge	Mediterranean				x									
App	<i>Allium porrum</i> subsp. <i>polyanthum</i>	Alliaceae	Ge	Mediterranean	R*								x			x	
Aro	<i>Allium roseum</i>	Alliaceae	Ge	Mediterranean					x						x		
Aal	<i>Amaranthus albus</i>	Amaranthaceae	Th	Introduced						x							
Aba	<i>Ambrosinia bassii</i>	Araceae	Ge	Subend Tyrrhenian									x	x			
Aar	<i>Ammophila arenaria</i>	Poaceae	He	Mediterranean				x	x								
Ama	<i>Ampelodesmos mauritanicus</i>	Poaceae	He	Mediterranean								x	x	x			
Ain	<i>Andryala integrifolia</i>	Asteraceae	Th	Mediterranean											x		
Ala	<i>Andryala laxiflora</i>	Asteraceae	Th	Ibero-maghrebian	VR							x					
Ani	<i>Andryala nigricans</i>	Asteraceae	Th	End Alg-Tun-Mor	R		P	x									
Ars	<i>Anisantha rubens</i>	Poaceae	Th	Mediterranean										x	x		
Amr	<i>Anthemis maritima</i>	Asteraceae	He	Mediterranean	R*			x	x	x	x	x	x	x			x
Ase	<i>Anthemis secundiramea</i>	Asteraceae	Th	Mediterranean	R			x	x								
Abj	<i>Anthyllis barba-jovis</i>	Fabaceae	Ph	Mediterranean	R				x		x	x					
Avu	<i>Arisarum vulgare</i>	Araceae	Ge	Mediterranean					x	x	x	x	x	x			
Amu	<i>Armeria mauritanica</i>	Plumbaginaceae	He	End Alg-Mor	FC							x					
Aab	<i>Artemisia arborescens</i>	Asteraceae	Ph	Cultivated									x				
Amc	<i>Arthrocaulon macrostachyum</i>	Amaranthaceae	Ph	Mediterranean					x	x						x	
Ait	<i>Arum italicum</i>	Araceae	Ge	Euri- Mediterranean					x	x			x				
Aac	<i>Asparagus acutifolius</i>	Asparagaceae	Ph	Mediterranean					x	x	x		x	x			
Aau	<i>Asparagus albus</i>	Asparagaceae	Ph	Mediterranean				x	x						x		
Alv	<i>Asperula laevigata</i>	Rubiaceae	He	Mediterranean				x	x								
Arr	<i>Asphodelus ramosus</i>	Asphodelaceae	Ge	Mediterranean				x							x		
Ape	<i>Astragalus pelecinus</i>	Fabaceae	Th	Euri- Mediterranean													x
Apa	<i>Atriplex patula</i>	Amaranthaceae	Th	Euri- Mediterranean						x							
Apr	<i>Atriplex prostrata</i>	Amaranthaceae	Th	Mediterranean								x					x
Acy	<i>Austrocylindropuntia cylindrica</i>	Cactaceae	Ph	Introduced							x						
Ast	<i>Avena sterilis</i>	Poaceae	Th	Subcosmopolitan							x		x	x			
Baa	<i>Bellis annua</i>	Asteraceae	Th	Mediterranean				x	x	x		x	x	x			
Bvu	<i>Beta vulgaris</i> subsp. <i>maritima</i>	Amaryllidaceae	He	Euri- Mediterranean						x	x			x		x	
Bdi	<i>Biscutella didyma</i>	Brassicaceae	Th	Mediterranean						x				x			x
Bbi	<i>Bituminaria bituminosa</i>	Fabaceae	He	Mediterranean								x					
Bpg	<i>Blackstonia perfoliata</i> subsp. <i>grandiflora</i>	Gentianaceae	Th	Euri- Mediterranean					x					x			
Bfr	<i>Brassica fruticulosa</i> subsp. <i>numidica</i>	Brassicaceae	Ch	Endemic Algeria	VR*							x					
Bin	<i>Brassica insularis</i>	Brassicaceae	Ch	Subend Tyrrhenian	VR	NT						x					
Bpr	<i>Brassica procumbens</i>	Brassicaceae	Th	End Alg-Tun									x	x			
Bma	<i>Briza maxima</i>	Poaceae	Th	Mediterranean							x				x		x
Csb	<i>Calendula suffruticosa</i> subsp. <i>foliosa</i>	Asteraceae	Ch	End Alg-Tun-Mor	R					x		x					x
Cvi	<i>Calicotome villosa</i>	Fabaceae	Ph	Mediterranean					x			x	x				
Cso	<i>Calystegia soldanella</i>	Convolvulaceae	Ge	Cosmopolitan	VR			x									
Cdi	<i>Campanula dichotoma</i>	Campanulaceae	Th	Mediterranean									x	x			
Cre	<i>Carex remota</i>	Cyperaceae	He	Mediterranean									x				
Ced	<i>Carpobrotus edulis</i>	Aizoaceae	Ch	Introduced													x
Cma	<i>Catapodium marinum</i>	Poaceae	Th	Mediterranean-atlantic				x	x	x							x
Cna	<i>Centaurea napifolia</i>	Asteraceae	Th	Mediterranean						x	x	x					
Cpa	<i>Centaurea papposa</i>	Asteraceae	Ch	End Alg-Tun	VR							x					
Cmj	<i>Cerithe major</i>	Boraginaceae	Th	Mediterranean								x	x				
Chu	<i>Chamaerops humilis</i>	Aracaceae	Ph	Mediterranean				x	x		x	x	x	x			

Code	Taxon	Family	BT	BD	Sc	IU	JO	1	2	3	4	5	6	7	8	9	10
Cal	<i>Chenopodium album</i>	Chenopodiaceae	Th	Subcosmopolite						x					x		
Cmu	<i>Chenopodium murale</i>	Chenopodiaceae	Th	Subcosmopolitan						x							
Cfl	<i>Clematis flammula</i>	Ranunculaceae	Ph	Mediterranean									x				
Cmy	<i>Coleostephus myconis</i>	Asteraceae	Th	Mediterranean				x									
Cat	<i>Convolvulus arvensis</i>	Convolvulaceae	Ge	Mediterranean									x	x			
Cel	<i>Convolvulus elegantissimus</i>	Convolvulaceae	Ge	Mediterranean											x		
Csu	<i>Conyza sumatrensis</i>	Asteraceae	Th	Introduced						x							
Cli	<i>Corrigiola litoralis</i>	Caryophyllaceae	Th	Mediterranean				x		x		x					
Cmr	<i>Crithmum maritimum</i>	Apiaceae	Ch	Mediterranean-atlantic					x		x	x	x	x	x		x
Cmt	<i>Cutandia maritima</i>	Poaceae	Th	Mediterranean				x	x			x					
Cda	<i>Cynodon dactylon</i>	Poaceae	Ge	Cosmopolitan						x			x	x			x
Cec	<i>Cynosurus echinatus</i>	Poaceae	Th	Mediterranean-atlantic											x		
Cca	<i>Cyperus capitatus</i>	Cyperaceae	He	Mediterranean				x			x						
Dgh	<i>Dactylis glomerata</i> subsp. <i>hackelii</i>	Poaceae	He	Mediterranean				x	x		x	x	x	x		x	x
Dgn	<i>Daphne gnidium</i>	Thymelaeaceae	Ph	Mediterranean										x			
Dch	<i>Daucus carota</i> subsp. <i>hispanicus</i>	Apiaceae	He	Mediterranean				x	x	x	x	x					x
Rpo	<i>Daucus rouyi</i>	Apiaceae	He	Subend Tyrrhenian	R	EN		x			x						
Dsy	<i>Dianthus sylvestris</i> subsp. <i>aristidis</i>	Caryophyllaceae	He	Endemic Algeria	R							x			x		
Dco	<i>Dioscorea communis</i>	Dioscoreaceae	He	Mediterranean-										x	x		
Dgr	<i>Diurichia graveolens</i>	Asteraceae	Th	Mediterranean					x				x				
Dvi	<i>Diurichia viscosa</i>	Asteraceae	Ph	Mediterranean						x							
Dfu	<i>Drimia fugax</i>	Hyacinthaceae	Ge	Mediterranean								x		x			x
Dnu	<i>Drimia numidica</i>	Hyacinthaceae	Ge	End Alg-Tun-Boreal					x					x	x		
Epl	<i>Echium plantagineum</i>	Boraginaceae	Th	Mediterranean						x		x	x	x			
Efr	<i>Ephedra fragilis</i>	Ephedraceae	Ph	Mediterranean				x	x		x	x			x		
Ebo	<i>Erigeron bonariensis</i>	Asteraceae	Th	Introduced						x							
Eca	<i>Erigeron canadensis</i>	Asteraceae	Th	Introduced						x							x
Eae	<i>Erodium aethiopicum</i>	Geraniaceae	Th	Mediterranean	R						x						
Ema	<i>Erodium malacoides</i>	Geraniaceae	Th	Mediterranean					x								
Edi	<i>Eryngium dichotomum</i>	Apiaceae	He	Euri- Mediterranean								x					
Emr	<i>Eryngium maritimum</i>	Apiaceae	He	Mediterranean-atlantic				x									
Ede	<i>Euphorbia dendroides</i>	Euphorbiaceae	Ph	Mediterranean	R		P					x					
Eex	<i>Euphorbia exigua</i>	Euphorbiaceae	Th	Mediterranean				x	x								
Ehh	<i>Euphorbia helioscopia</i>	Euphorbiaceae	Th	Subcosmopolitan						x					x		
Epa	<i>Euphorbia paralias</i>	Euphorbiaceae	Ch	Mediterranean-atlantic											x		
Epe	<i>Euphorbia peplis</i>	Euphorbiaceae	Th	Mediterranean											x		
Etr	<i>Euphorbia terracina</i>	Euphorbiaceae	Th	Mediterranean											x		
Fgr	<i>Fedia graciliflora</i>	Valerianaceae	Th	Mediterranean								x	x	x			
Fco	<i>Ferula communis</i>	Apiaceae	He	Mediterranean								x		x			
Flu	<i>Ferulago lutea</i>	Apiaceae	He	Mediterranean								x		x			
Fce	<i>Festuca coerulescens</i>	Poaceae	He	Mediterranean								x		x			
Fca	<i>Ficus carica</i>	Moraceae	Ph	Mediterranean								x					
Fhi	<i>Frankenia hirsuta</i>	Frankeniaceae	He	Mediterranean					x	x							
Fbi	<i>Fumaria bicolor</i>	Papaveraceae	Th	Mediterranean	R				x		x						
Fcp	<i>Fumaria capreolata</i>	Papaveraceae	Th	Mediterranean-atlantic						x					x		
Gmu	<i>Galactites mutabilis</i>	Asteraceae	Th	End Alg-Tun	FR							x	x	x			
Gte	<i>Galactites tomentosus</i>	Asteraceae	Th	Mediterranean											x		
Gap	<i>Galium aparine</i>	Rubiaceae	Th	Mediterranean					x								
Gve	<i>Galium verrucosum</i>	Rubiaceae	Th	Mediterranean				x				x					
Gff	<i>Genista ferox</i>	Fabaceae	Ph	End Alg-Tun					x			x	x				
Gnn	<i>Genista numidica</i>	Fabaceae	Ph	Endemic Algeria								x		x			
Gro	<i>Geranium robertianum</i>	Geraniaceae	Th	Eurasian						x							
Gdu	<i>Gladiolus dubius</i>	Iridaceae	Ge	Mediterranean					x			x	x	x			

Code	Taxon	Family	BT	BD	Sc	IU	JO	1	2	3	4	5	6	7	8	9	10
Gfl	<i>Glaucium flavum</i>	Papaveraceae	He	Mediterranean-atlantic						x							
Gse	<i>Glebionis segetum</i>	Asteraceae	Th	Mediterranean										x			
Hpo	<i>Halimione portulacoides</i>	Amaranthaceae	Ph	Subcosmopolitan							x						
Hpe	<i>Helichrysum pendulum</i>	Asteraceae	Ch	Mediterranean								x		x			
Hcu	<i>Heliotropium curassavicum</i>	Boraginaceae	Ch	Introduced						x							
Hal	<i>Hyoscyamus albus</i>	Solanaceae	He	Introduced						x							
Hra	<i>Hyoseris radiata</i>	Asteraceae	He	Mediterranean				x	x	x	x			x	x		
Hhi	<i>Hyparrhenia hirta</i>	Poaceae	He	Mediterranean								x		x			
Hpe	<i>Hypericum perforatum</i>	Hypericaceae	He	Mediterranean										x			
Hac	<i>Hypochaeris achyrophorus</i>	Asteraceae	Th	Mediterranean						x		x		x			
Hrd	<i>Hypochoeris radicata</i>	Asteraceae	He	Euri- Mediterranean										x			
Iun	<i>Iris unguicularis</i>	Iridaceae	Ge	End Alg-Tun											x		
Jma	<i>Jacobaea maritima</i>	Asteraceae	Ch	Introduced						x							
Jmr	<i>Juncus maritimus</i>	Juncaceae	Ge	Subcosmopolitan													
Jox	<i>Juniperus oxycedrus</i>	Cupressaceae	Ph	Mediterranean				x	x		x			x			
Jpt	<i>Juniperus phoenicea</i> subsp. <i>turbinata</i>	Cupressaceae	Ph	Mediterranean-atlantic				x	x		x						
Lau	<i>Lamarckia aurea</i>	Poaceae	Th	Euri- Mediterranean								x					
Lcl	<i>Lathyrus clymenum</i>	Fabaceae	Th	Euri- Mediterranean											x		
Lcr	<i>Limbaria crithmoides</i>	Asteraceae	Ch	Méditerano-				x	x	x							x
Lfr	<i>Limonium fradinianum</i>	Plumbaginaceae	He	Endemic Algeria ?	FR*						x	x		x			x
Lss	<i>Limonium spathulatum</i>	Plumbaginaceae	He	End Alg-Tun-Mpr-Spa	R		P	x	x					x	x		x
Lvi	<i>Limonium virgatum</i>	Plumbaginaceae	He	Mediterranean	R		P	x	x	x							
Lfl	<i>Linaria flava</i>	Scrophulariaceae	Th	Mediterranean	R	NT		x									
Lre	<i>Linaria reflexa</i>	Scrophulariaceae	Th	Mediterranean						x		x	x	x			
Lbi	<i>Linum bienne</i>	Linaceae	Th	Mediterranean-atlantic					x			x					
Lma	<i>Lobularia maritima</i>	Brassicaceae	Ch	Mediterranean					x			x	x	x			
Lcc	<i>Lotus corniculatus</i>	Fabaceae	He	Euri- Mediterranean										x			
Lct	<i>Lotus creticus</i>	Fabaceae	Ch	Mediterranean				x	x	x	x						
Lcy	<i>Lotus cytisoides</i>	Fabaceae	He	Mediterranean						x	x	x					x
Lde	<i>Lotus drepanocarpus</i>	Fabaceae	He	End Alg-Tun	R		P	x	x			x					x
Lar	<i>Lysimachia arvensis</i>	Primulaceae	Th	Holarctic					x					x	x		x
Mar	<i>Malva arborea</i>	Malvaceae	Ph	Mediterranean	R*												x
Msy	<i>Malva sylvestris</i>	Malvaceae	Th	Paleotemperate						x		x	x				x
Mtr	<i>Malva trimestris</i>	Malvaceae	Th	Mediterranean						x							
Mii	<i>Matthiola incana</i>	Brassicaceae	Ch	Mediterranean	VR						x			x			
Mti	<i>Matthiola tricuspidata</i>	Brassicaceae	Th	Mediterranean								x					
Mmi	<i>Medicago minima</i>	Fabaceae	Th	Paleotemperate										x			
Mmu	<i>Medicago murex</i>	Fabaceae	Th	Mediterranean					x								
Min	<i>Melilotus indicus</i>	Fabaceae	Th	Mediterranean										x	x		
Maa	<i>Mercurialis annua</i> subsp. <i>ambigua</i>	Urticaceae	Th	Subcosmopolitan					x	x		x	x	x			
Mno	<i>Mesembryanthemum nodiflorum</i>	Aizoaceae	Th	Mediterranean													x
Msi	<i>Moraea sisyrinchium</i>	Iridaceae	Ge	Euri- Mediterranean						x					x		
Oeu	<i>Olea europaea</i>	Oleaceae	Ph	Mediterranean					x					x			
Ope	<i>Oncostema peruviana</i>	Asparagaceae	Ge	Mediterranean											x		
Obo	<i>Ophrys bombyliflora</i>	Orchidaceae	Ge	Mediterranean											x		
Osp	<i>Ophrys speculum</i>	Orchidaceae	Ge	Mediterranean											x		
Ott	<i>Ophrys tenthredinifera</i>	Orchidaceae	Ge	Mediterranean											x		
Ofi	<i>Opuntia ficus-indica</i>	Cactaceae	Ph	Naturalized							x			x			
Ost	<i>Opuntia stricta</i>	Cactaceae	Ph	Introduced						x							
Omi	<i>Orobanche minor</i>	Orobanchaceae	Th	Mediterranean								x		x			
Opc	<i>Oxalis pes-caprae</i>	Oxalidaceae	Ge	Introduced				x	x	x				x	x		x
Pma	<i>Pallenis maritima</i>	Asteraceae	Ch	Mediterranean						x		x		x			x
Pmr	<i>Pancratium maritimum</i>	Amaryllidaceae	Ge	Mediterranean				x	x								
Psa	<i>Phagnalon saxatile</i>	Asteraceae	Ch	Mediterranean								x	x	x			
Pla	<i>Phillyrea latifolia</i>	Oleaceae	Ph	Mediterranean				x	x		x	x		x			

Code	Taxon	Family	BT	BD	Sc	IU	JO	1	2	3	4	5	6	7	8	9	10
Tdi	<i>Trachynia distachya</i>	Poaceae	Th	Euri- Mediterranean						x							
Tca	<i>Trifolium campestre</i>	Fabaceae	Th	Euri- Mediterranean					x			x		x			
Tre	<i>Trifolium repens</i>	Fabaceae	He	Mediterranean				x	x					x			
Uru	<i>Umbilicus rupestris</i>	Crassulaceae	Ge	Mediterranean-atlantic							x		x	x			
Upi	<i>Urospermum picroides</i>	Asteraceae	Th	Mediterranean				x				x	x				
Upl	<i>Urtica pilulifera</i>	Urticaceae	Th	Mediterranean										x			
Vmu	<i>Valantia muralis</i>	Rubiaceae	Th	Mediterranean	R			x	x		x	x					
Val	<i>Vicia altissima</i>	Fabaceae	He	Mediterranean											x		
Xst	<i>Xanthium strumarium</i>	Asteraceae	Th	Introduced							x						

Appendix 2. Floristic appendix. List of plants studied in the present paper with the corresponding authors.

Achyranthes aspera L.; *Allium commutatum* Guss.; *Allium multiflorum* Desf.; *Allium porrum* L. subsp. *polyanthum* (Schult. & Schult. f.) Jauzein & J.-M. Tison; *Allium roseum* L.; *Amaranthus albus* L.; *Ambrosinia bassii* L.; *Ammophila arenaria* (L.) Link; *Ampelodesmos mauritanicus* (Poir.) T. Durand & Schinz; *Andryala integrifolia* L.; *Andryala laxiflora* DC.; *Andryala nigricans* Poir.; *Anisantha rubens* (L.) Nevski; *Anthemis maritima* L. subsp. *maritima*; *Anthemis secundiramea* Biv.; *Anthyllis barba-jovis* L.; *Arisarum vulgare* O. Targ. Tozz. subsp. *vulgare*; *Armeria mauritanica* Wallr.; *Artemisia arborescens* (Vaill.) L.; *Arthrocaulon macrostachyum* (Moric.) Piirainen & G. Kadereit; *Arum italicum* Mill.; *Asparagus acutifolius* L.; *Asparagus albus* L.; *Asperula laevigata* L.; *Asphodelus ramosus* L. subsp. *ramosus*; *Astragalus pelecinus* (L.) Barneby; *Atriplex patula* L.; *Atriplex prostrata* Boucher ex DC.; *Austrocylindropuntia cylindrica* (Lam.) Backeb.; *Avena sterilis* L.; *Bellis annua* L. subsp. *annua*; *Beta vulgaris* L. subsp. *maritima* (L.) Arcang.; *Biscutella didyma* L.; *Bituminaria bituminosa* (L.) C. H. Stirt.; *Blackstonia perfoliata* subsp. *grandiflora* Viv. Maire; *Brassica fruticulosa* Cirillo subsp. *numidica* (Coss.) Maire; *Brassica insularis* Moris; *Brassica procumbens* (Poir.) O. E. Schulz; *Briza maxima* L.; *Calendula suffruticosa* Vahl subsp. *foliosa* (Batt.) A.C. Gonç. & P. Silveira; *Calicotome villosa* (Poir.) Link subsp. *villosa*; *Calystegia soldanella* (L.) R. Br. ex Roem. & Schult.; *Campanula dichotoma* L.; *Carex remota* L.; *Carpobrotus edulis* (L.) N.E. Br.; *Catapodium marinum* (L.) C. E. Hubb.; *Centaurea napifolia* L.; *Centaurea papposa* (Coss.) Greuter; *Cerinthe major* L.; *Chamaerops humilis* L.; *Chenopodium album* L.; *Chenopodium murale* L.; *Clematis flammula* L.; *Coleostephus myconis* (L.) Rchb. f.; *Convolvulus arvensis* L.; *Convolvulus elegantissimus* Mill.; *Conyza sumatrensis* (Retz.) E. Walker; *Corrigiola litoralis* L.; *Crithmum maritimum* L.; *Cutandia maritima* (L.) Benth.; *Cynodon dactylon* (L.) Pers.; *Cynosurus echinatus* L.; *Cyperus capitatus* Vand.; *Dactylis glomerata* L. subsp. *hackelii* (Asch. & Graebn.) Cif. & Giacom.; *Daphne gnidium* L.; *Daucus carota* L. subsp. *hispanicus* (Gouan) Thell.; *Daucus rouyi* Spalik & Reduron; *Dianthus sylvestris* Wulfen subsp. *aristidis* (Batt.) Greuter & Burdet; *Dioscorea communis* (L.) Caddick & Wilkin; *Dittrichia graveolens* (L.) Greuter; *Dittrichia viscosa* (L.) Greuter; *Drimia fugax* (Moris) Stearn; *Drimia numidica* (Jord. & Fourr.) J. C. Manning & Goldblatt; *Echium plantagineum* L.; *Ephedra fragilis* Desf.; *Erigeron bonariensis* L.; *Erigeron canadensis* L.; *Erodium aethiopicum* (Lam.) Brumh. & Thell.; *Erodium malacoides* (L.) L'Hér.; *Eryngium dichotomum* Desf.; *Eryngium maritimum* L.; *Euphorbia dendroides* L.; *Euphorbia exigua* L.; *Euphorbia helioscopia* L. subsp. *helioscopia*; *Euphorbia paralias* L.; *Euphorbia peplis* L.; *Euphorbia terracina* L.; *Fedia graciliflora* Fisch. & C. A. Mey.; *Ferula communis* L. subsp. *communis*; *Ferulago lutea* (Poir.) Grande; *Festuca coerulescens* Desf.; *Ficus carica* L.; *Frankenia hirsuta* L.; *Fumaria bicolor* Nicotra; *Fumaria capreolata* L.; *Galactites mutabilis* Durieu; *Galactites tomentosus* Moench; *Galium aparine* L.; *Galium verrucosum* Huds.; *Genista ferox* (Poir.) Dum. Cours. subsp. *ferox*; *Genista numidica* Spach subsp. *numidica*; *Geranium robertianum* L.; *Gladiolus dubius* Guss.; *Glaucium flavum* Crantz; *Glebionis segetum* (L.) Fourr.; *Halimione portulacoides* (L.) Aellen; *Helichrysum pendulum* (C. Presl) C. Presl; *Heliotropium curassavicum* L.; *Hyoscyamus albus* L.; *Hyoseris radiata* L.; *Hyparrhenia hirta* (L.) Stapf; *Hypericum perforatum* L.; *Hypochoeris achyrophorus* L.; *Hypochoeris radicata* L.; *Iris unguicularis* Poir.; *Jacobaea maritima* (L.) Pelser & Meijden; *Juncus maritimus* Lam.; *Juniperus oxycedrus* L.; *Juniperus phoenicea* L. subsp. *turbinata* (Guss.) Arcang.; *Lamarckia aurea* (L.) Moench; *Lathyrus clymenum* L.; *Limbaria crithmoides* (L.) Dumort.; *Limonium fradinianum* (Pomel) Erben; *Limonium spathulatum* (Desf.) O. Kuntze subsp. *spathulatum*; *Limonium virgatum* (Willd.) Fourr.; *Linaria flava* (Poir.) Desf.; *Linaria reflexa* (L.) Chaz.; *Linum bienne* Mill.; *Lobularia maritima* (L.) Desv.; *Lotus corniculatus* L. subsp. *corniculatus*; *Lotus creticus* L.; *Lotus cytisoides* L.; *Lotus drepanocarpus* Durieu; *Lysimachia arvensis* (L.) U. Manns & Anderb.; *Malva arborea* (L.) Webb & Berthel.; *Malva sylvestris* L.; *Malva trimestris* (L.) Salisb.; *Matthiola incana* (L.) R. Br. subsp. *incana*; *Matthiola tricuspidata* (L.) R. Br.; *Medicago minima* (L.) L.; *Medicago murex* Willd.; *Melilotus indicus* (L.) All.; *Mercurialis annua* L. subsp. *ambigua* (L. f.) Arcang.; *Mesembryanthemum nodiflorum* L.; *Moraea sisyrinchium* (L.) Ker Gawl.; *Olea europaea* L.; *Oncostema peruviana* (L.) Speta; *Ophrys bombyliflora* Link; *Ophrys speculum* Link; *Ophrys tenthredinifera* Willd. subsp. *tenthredinifera*; *Opuntia ficus-indica* (L.) Mill.; *Opuntia stricta* (Haw.) Haw.; *Orbanche minor* Sm.; *Oxalis pes-caprae* L.; *Pallenis maritima* (L.) Greuter; *Pancreatum maritimum* L.; *Phagnalon saxatile* (L.) Cass.; *Phillyrea latifolia* L.; *Pinus pinaster* Aiton; *Pistorinia breviflora* Boiss. subsp. *breviflora*; *Pistacia lentiscus* L.; *Plantago lagopus* L.; *Plantago lanceolata* L.; *Plantago macrorhiza* Poir. subsp. *macrorhiza*; *Plantago serraria* L.; *Poa annua* L. subsp. *annua*; *Polycarpon tetraphyllum* subsp. *catalaunicum* (O. Bolòs & Vigo) Iamónico & Domina; *Polygonum aviculare* L.; *Polygonum maritimum* L.; *Portulaca oleracea* L.; *Prasium majus* L.; *Reichardia picroides* (L.) Roth; *Reseda alba* L.; *Retama raetam* (Forssk.) Webb subsp. *bovei* (Spach) Talavera & Gibbs; *Rhaponticum acaule* (L.) DC.; *Rhodalsine geniculata* (Poir.) F. N. Williams; *Romulea bulbocodium* (L.) Sebast. & Mauri subsp. *bulbocodium*; *Romulea ligustica* Parl.; *Rubia peregrina* L. subsp. *longifolia* (Poir.) O. Bolòs; *Rubus ulmifolius* Schott; *Rumex bucephalophorus* L.; *Ruscus hypophyllum* L.; *Ruta chalepensis* L.; *Sarcocornia fruticosa* (L.) A. J. Scott; *Securigera atlantica* Boiss. & Reut.; *Sedum caeruleum* L.; *Sedum tuberosum* Coss. &

Sedum tuberosum Coss. & Letourn.; *Senecio leucanthemifolius* Poir. subsp. *leucanthemifolius*; *Senecio vulgaris* L.; *Seseli praecox* (Gamisans) Gamisans; *Sherardia arvensis* L.; *Sideritis romana* L. subsp. *numidica* Batt.; *Silene colorata* L.; *Silene gallica* L.; *Silene nicaeensis* All.; *Silene sedoides* Poir.; *Smilax aspera* L.; *Sisalix farinosa* (Coss.) Greuter & Burdet; *Solanum bonariense* L.; *Solanum linnaeanum* Hepper & P.-M. L. Jaeger; *Sonchus asper* L. subsp. *glaucescens* (Jord.) Ball; *Sonchus bulbosus* (L.) Kilian & Greuter; *Sonchus oleraceus* L.; *Sonchus tenerrimus* L.; *Spergula arvensis* L.; *Sporobolus pungens* (Schreb.) Kunth; *Stachys marrubifolia* Viv.; *Stachys ocymastrum* (L.) Briq.; *Symphyotrichum squamatum* (Spreng.) G. L. Nesom; *Tamarix gallica* L.; *Tetragonolobus biflorus* (Desr.) DC.; *Tetragonolobus maritimus* (L.) Roth; *Teucrium fruticans* L.; *Thymelaea hirsuta* (L.) Endl.; *Trachynia distachya* (L.) Link; *Trifolium campestre* L.; *Trifolium repens* L.; *Umbilicus rupestris* (Salisb.) Dandy; *Urospermum picroides* (L.) Scop. ex F. W. Schmidt; *Urtica pilulifera* L.; *Valantia muralis* (L.) DC.; *Vicia altissima* Desf.; *Xanthium strumarium* L.

